

USG BORAL HEALTHCARE GUIDE



USG BORAL
INNOVATION INSPIRED BY YOU.™



[USGBoral.com](https://www.usgboral.com)

Plasterboard

Ceilings

Interior Finishes

Metal Framing

Substrates



CONTENTS

Introduction	04
USG Boral Presence In Healthcare Projects	06
Projects Reference	
Case Study	
Typical Hospital Floor Plan	08
Healthcare Drywall Partition Assemblies	13
USG Boral Wallboards for Healthcare Applications	14
Hospital Exterior Finishing	20
Patient Room to Patient Room (Wall-Same Floor)	
Exam Room to Exam Room (With Electronic Masking)	22
Patient Room to Patient Room (Floor-To- Floor)	
Exam Room to Exam Room (No Electronic Masking)	23
NICU to Corridor	24
Treatment Room to Treatment Room	
Operating Room to Operating Room	25
Toilet Room to Public Space	26
Patient Room to Corridor (With Entrance)	
Consultation Room to Corridor (With Entrance)	27
Patient Room to Service Area	28
Out-Patient/Consultation Room to Public Space	29
Operating Room to MRI Room	
Patient Room to MRI Room	30
Shaftwall System	31
Healthcare Ceiling Solutions	32
ENSEMBLE™ Monolithic Acoustical Ceiling System	36
Metal Ceiling Clip in	38
Metal Torsion Spring Ceiling System	40
Clean Room Non-Perforated	42
Louna™	44
HALCYON™ Healthcare	46
Sonata Healthcare	48
Sparta	50
Taiga Hygiene	52
DONN® Exposed Grid for healthcare Application	54
DONN® Suspension system Seismic Solutions	56
Environmental Air Quality	58
Mold Prevention	59
Healthcare Interior Finishes	60
Finishing Solutions	62
Company Certification and Compliance	66

TABLES

Table 1: Maximum Design Criteria for Noise in Interior Spaces Caused by Building Systems	11
Table 2: Design Criteria For Speech Privacy For Enclosed Rooms And Open-Plan Spaces	12
Table 3: Performance Tables Partition Grades	16
Table 4: Design Criteria For Minimum Sound Isolation Performance Between Enclosed Rooms	17
Table 5: Recommended Partition Sound Rating For Different Privacy Requirements	18
Table 6: Minimum Recommended Levels Of Airborne Sound Insulation Between Spaces	19
Table 7: Healthcare Ceiling Requirements	34
Table 8: USG Boral Recommended Ceilings Products	35
Table 9: Metal Ceiling Clip In Suspension Components	38
Table 10: Clean Room™ Classification	58



INTRODUCTION

With over 334 UL assemblies for Ceilings & Drywall Partitions; USG Boral ME is committed to provide innovative products and solutions to build your projects.

We are your single source manufacturer for Acoustical Ceiling Systems & Drywall Partitions Assemblies.

- Our systems are integrated with MEP and Lighting.
- Compatibility with claddings (Marble, Ceramic and Porcelain)
- Compatibility with other materials and systems (Sound systems, sprinklers, paint...)

USG Boral ME maintains a longstanding commitment with its employees, customers and communities to reduce environmental impact by using recycled materials whenever feasible to eliminate manufacturing waste. USG Boral ME products contribute toward LEED® credits in different areas. The company has a technical team that offers technical support for all healthcare projects scales at no cost whenever it is required by the clients, consultants or contractors.

WALL BOARDS

The USG Boral DryWall Partitions Systems are particularly designed to suite the sensitive requirements for all Healthcare applications. Our systems are designed to provide an enhanced acoustic, fire and structural performance with the latest International Building Code (IBC).

ACOUSTICAL CEILING TILES

USG Boral ME locally produces in its Dammam, KSA operation a wide range of acoustical ceiling tiles that covers Mineral Fiber, Soft Fiber, Specialty Ceilings, Metal Tiles and Gypsum Tiles. All Acoustical Ceiling Tiles produced by USG Boral ME comply with both international standards ASTM E1264 and EN 13964.

USG Boral ME acoustical ceilings are designed to increase the aesthetic and functional value of your interiors within a modest ceiling budget. USG Boral ME famous DONN® grid suspension is manufactured locally and is certified to meet the most stringent national and international standards.

METAL FRAMINGS

USG Boral ME is dedicated to provide high quality Metal Framing products including full range of accessories meeting the project needs and in compliance with the statutory and regulatory requirements.

INTERIOR FINISHES

USG Boral ME manufactures and supplies an extensive range of high-quality and consistent joint compounds including bedding and base compounds, finishing compounds, all purpose for patching and skimming compounds to transform your plasterboard joints, angles and fastener heads into one seamless surface.

SUBSTRATES

We design our substrates with ease of use and durability in mind so you can meet your project objectives. Explore our products and learn how you can utilize them for your Healthcare Projects. We produce and supply Durock® Cement Boards, Fiberock® Panels and Securock® Panels.

USG BORAL PRESENCE IN HEALTHCARE PROJECTS

BAHRAIN

- Awali Cardiac Hospital
- BDF Polyclinic
- King Hamad University Hospital

EGYPT

- Dar Al Fouad Hospital

GREECE

- Bioiatriki Medical Center

JORDAN

- Al-Kindi Hospital

KSA

- Al Dara Hospital
- Al Salam Hospital
- Dallah Hospital Extension
- Dammam General Hospital-ER Expansion
- Dr. Sulaiman Al Habib Hospital
- Fajar Al Dammam Medical Complex
- King Faisal Specialist Hospital and Research Center -KFSH&RC Mega Expansion
- Royal Commission General Hospital
- Saad Specialist Hospital
- Sinopec Research Center
- Specialized Medical Center-SMC
- Tabuk Hospital
- Um Al Qura University Teaching Hospital

KUWAIT

- Al-Amiri Hospital Expansion
- Farwaniya Hospital

LEBANON

- American University of Beirut Medical Center-AUBMC
- Rafic Hariri Hospital

OMAN

- Sultan Qaboos University Hospital

TURKEY

- Acibadem Adana Hospital
- Acibadem Atasehir Hospital
- Acibadem Hospital
- Dia Bilkent Health Center
- Kalyon Lutfi Kirdar Health Complex
- Medical Park Hospital
- Medicana Hospital Managerial Offices
- Turkerler Etlik Integrated Health Campus
- Umraniye Maternity Hospital

UNITED ARAB EMIRATES

- Al Mafraq Dialysis Center
- Al Maktoum Hospital Redevelopment
- Al Qassimi Hospital
- Cleveland Clinic
- Emirates Hospital
- Gargash Hospital
- Issaq Medical Center
- Mediclinic City Hospital
- Mediclinic Parkview Hospital
- National Rehabilitation Center
- Wagan Hospital

BILKENT INTEGRATED HEALTH CAMPUS

1.3 Million m²
Europe's largest health
campus of 8 hospitals

3804
Total Bed Capacity
The campus can serve up to
50,000 patients every day

300,000 m²
of Acoustical Ceiling and
Suspension Grid
USG Boral ME helped to
design an engineered fire
rated Seismic Grid for the
Complex ceiling areas



AWALI CARDIAC HOSPITAL

600,000 LM
of Metal Framing

USG Boral ME products were used to build the Bahraini most iconic integrated Healthcare Facility. Our Steel Profiles were used to build walls for 7 meter Height. Increased the speed of wall installations compared to traditional build while complying with fire rating and acoustic requirements

100,000 m²
of Plasterboard

Our Drywall systems helped to increase the construction productivity. Most of our drywall systems can be engineered to be up to 80% lighter than traditional systems

30,000 m²
of Substrates

Our Substrates boards had provided the critical impact resistance for walls to protect against high pedestrian traffic



TYPICAL HOSPITAL FLOOR PLAN

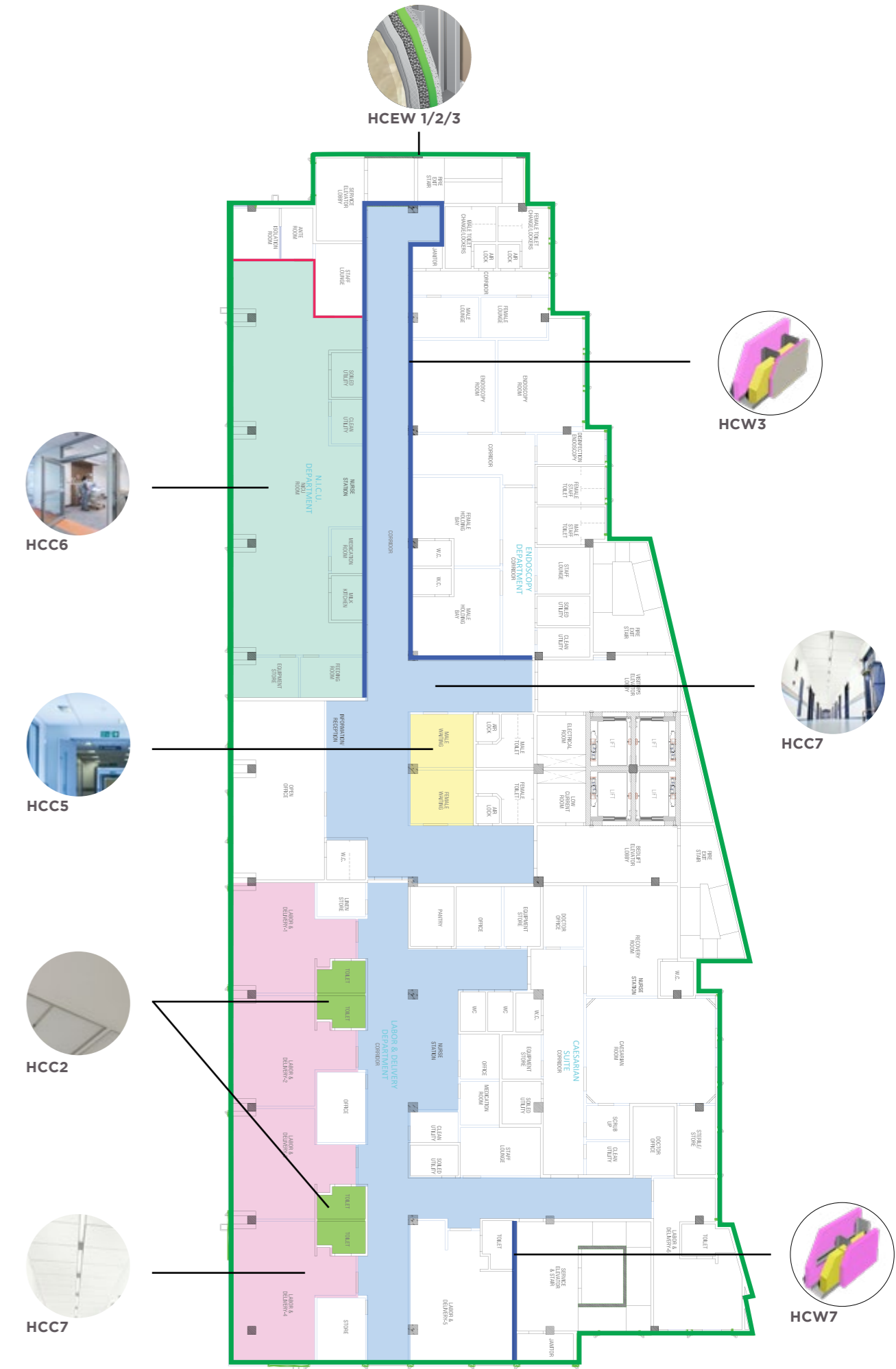
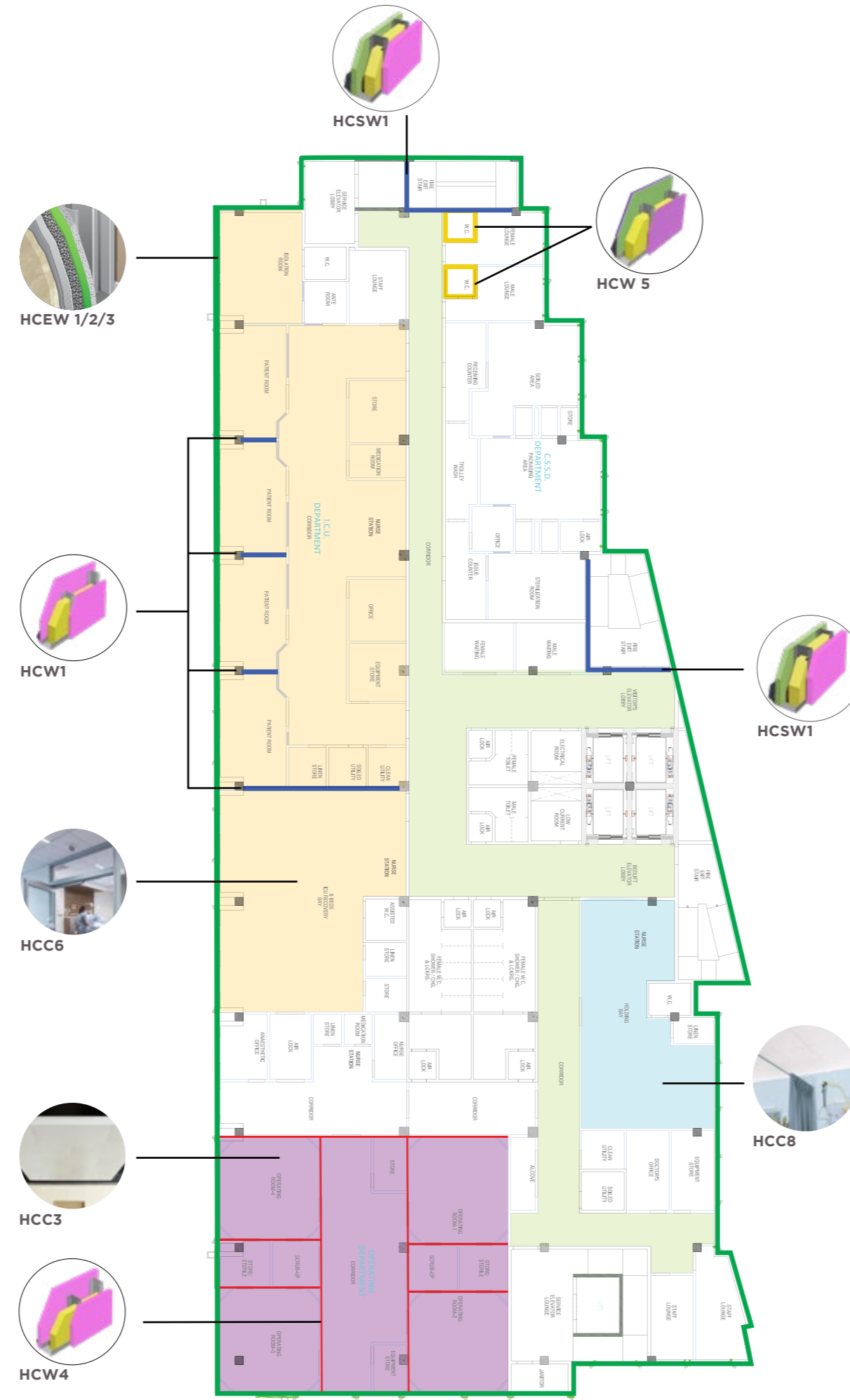
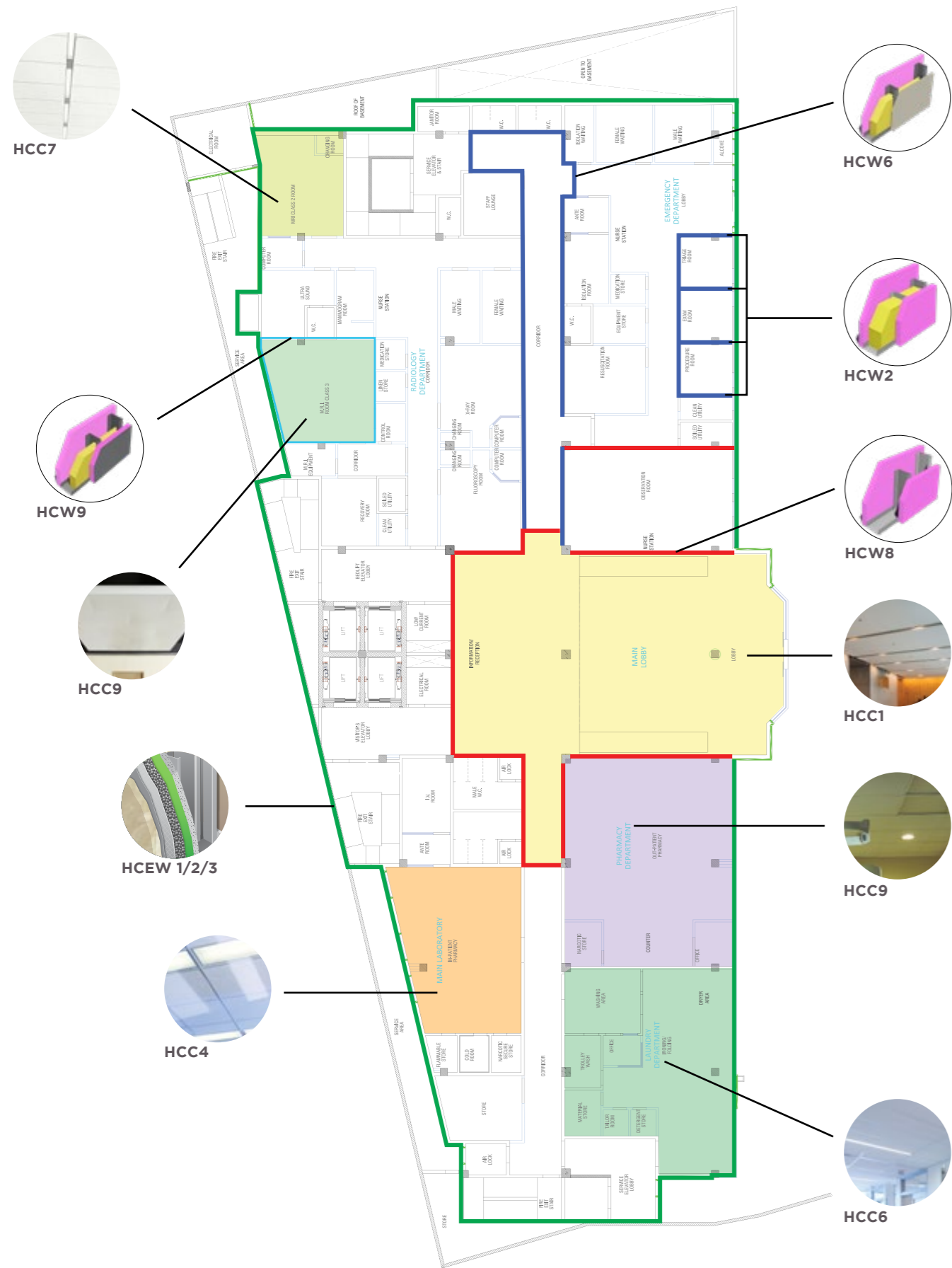

TABLE 1: MAXIMUM DESIGN CRITERIA FOR NOISE IN INTERIOR SPACES CAUSED BY BUILDING SYSTEMS¹

AS PER 2018 FGI GUIDELINES FOR DESIGN AND CONSTRUCTION OF HOSPITALS

Room Type	NC / RC(N) / RNC ^{2,3}	dB
Patient Care Units		
Patient Room	40	45
NICU Sleep Area	30	35
NICU Staff and Family Areas	35	40
Diagnostic and Treatment Locations		
Multiple-Occupant Patient Care Area	45	50
Examination/Treatment Room	40	45
Procedure Room	40	45
Class 2 Imaging Room	40	45
Operating Room ⁴	50	55
Class 3 Imaging Room ⁴	50	55
Support Areas		
Medication Safety Zone	40	45
Testing/Research Lab, Minimal Speech	55	60
Research Lab, Extensive Speech	50	55
Group Teaching Lab	45	50
Public Areas		
Corridor and Public Area	45	50
Conference Room	35	40
Teleconferencing Room	25	30
Auditorium Large Lecture Room	30	35
Administrative Areas		
Private Office	40	45

¹Additional spaces shall be added based on the building program.

²One rating system shall be chosen to evaluate room noise levels, and noise from building mechanical systems shall be evaluated using that same rating system.

³Spaces shall be designed to fall below the maximum values shown in this table with no rattles or tonal characteristics.

⁴See table 3 (Room noise levels in operating rooms) for more information on operating rooms.

TABLE 2: DESIGN CRITERIA FOR SPEECH PRIVACY FOR ENCLOSED ROOMS AND OPEN-PLAN SPACES^{1, 2}

AS PER 2018 FGI GUIDELINES FOR DESIGN AND CONSTRUCTION OF HOSPITALS

Level	Metrics			
Speech Privacy—Closed Plan	PI⁴	AI⁴	SII⁴	SPC⁴
Secure	N/A	N/A	N/A	≥70
Confidential	≥95%	≥0.05	≤0.10	60-69
Normal	80-94%	0.06-0.20	0.11-0.25	52-59
Defining standard	ASTM E1130	ASTM E1130	ANSI S3.5	ASTM E2638
Speech Privacy—Open Plan	PI⁴	AI⁴	SII⁴	SPC⁴
Confidential	Special Consideration Required ³			
Normal	80-94%	0.06-0.20	0.11-0.25	52-59
Marginal	60-79%	0.21-0.40	0.26-0.45	45-51
Defining standard	ASTM E1130	ASTM E1130	ANSI S3.5	ASTM E2638

¹The indicated AI and SII values shall be considered the maximum accepted values. The indicated PI and SPC values shall be considered the minimum accepted values.

²Equivalence among these metrics, as indicated, has been demonstrated. However, some of the metrics may not be suitable for a particular space. The referenced standards indicate that PI and SI are appropriate for use in open-plan spaces and that SPC is appropriate for closed-plan spaces. The referenced standard for SII indicates it may be used for either type of space.

³Confidential speech privacy is not readily achievable in open-plan spaces due to the lack of barriers, low ambient sound levels, and typical voice effort.

⁴(PI): Privacy Index, (AI): Articulation Index, (SII): Speech Transmission Index, (SPC): Speech Intelligibility Index



HEALTHCARE DRYWALL PARTITION ASSEMBLIES

WALLBOARDS FOR HEALTHCARE APPLICATIONS

USG BORAL SHEETROCK® BRAND GYPSUM PANELS | TYPE X, TYPE C AND REGULAR PANELS

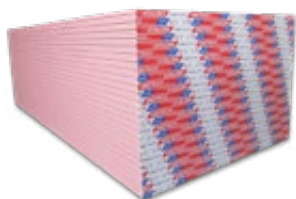

- Quality interior wall and ceiling panels at low cost
- Fire-resistant dry construction
- Score and snap easily
- Resist cracking and warping
- Specialized types for all systems
- Quick installation and decoration

USG BORAL SHEETROCK® BRAND GYPSUM PANELS WETSTOP MOISTURE RESISTANCE

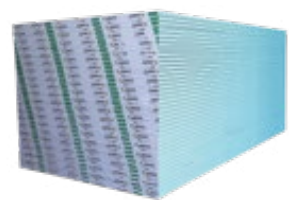

- Quality interior wall and ceiling panels where moisture resistance is required
- Score and snap easily
- Resist cracking and warping
- Quick installation and decoration

USG FIBEROCK® BRAND AR INTERIOR PANELS



- No face paper to scratch or tear
- Resist denting, breaking and puncturing, even in high-traffic areas as Hospitals corridors
- Provide excellent fire resistance
- Offer an economical alternative to concrete block and plaster construction
- Ideal for healthcare, education and commercial interiors
- Certified, recycled content of 97%

USG FIBEROCK® BRAND AQUA-TOUGH™ AR INTERIOR PANEL



- Aqua-Tough™ panels provide increased resistance to moisture and mold
- No face paper to scratch or tear
- Resist denting, breaking and puncturing, even in high-traffic areas as Hospitals corridors
- Provide excellent fire resistance
- Offer an economical alternative to concrete block and plaster construction
- Ideal for healthcare, education and commercial interiors
- Certified, recycled content of 97%

USG DUROCK® BRAND CEMENT BOARD



Backerboard for tile and exterior finish systems

- Lightweight cement tile backerboard
- Water-durable, mold-resistant substrate for high-moisture areas
- Suitable for use in interior or exterior applications
- Will not rot, warp, delaminate or disintegrate
- Easy to cut and fasten
- Noncombustible

USG BORAL SECUROCK® BRAND GLASS-MAT SHEATHING / REGULAR AND MOLD TOUGH®



- Treated gypsum core, combined with fiberglass face and back, offers exceptional water resistance
- Score and snap easily for quick installation
- For use in most exterior systems when properly detailed by exterior finish manufacturer
- Meets or exceeds the requirements of ASTM C1177
- UL Classified as to fire resistance, surface-burning characteristics and non-combustibility
- The backer for shower and bath areas surface-burning characteristics and non-combustibility

USG BORAL SECUROCK® BRAND GLASS-MAT LINER PANELS



- High-performance glass-mat panels with moisture and mold resistance for use in USG Boral Shaftwall and area separation wall systems
- Direct substitute for USG Boral Sheetrock® Brand gypsum liner panels and USG Boral Sheetrock® Brand Mold Tough™ gypsum liner panels when prolonged weather exposure is anticipated
- UL Classified as to fire resistance, surface burning characteristics and non-combustibility
- Comprehensive product and system testing ensures long-term performance and safety

USG SHEETROCK® BRAND LEAD LINED TYPE X BOARD 5/8" (15.9MM)

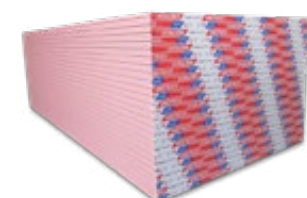

- Includes vertical batten strips and lead discs for screw penetrations
- Typically one day fabrication
- Lead thicknesses minimum 2.5mm thick lead
- Lead up to 7'0" (2.1336M) from floor
- Optional Mold Resistant, Abuse Resistant, High Impact and other specialized board types

STRUCTURAL STRENGTH

USG BORAL ME PARTITIONS - NON-LOAD BEARING

The strength of a partition is judged by its ability to resist deflection under load, or by the force needed to break through the partition when subjected to an impact by either a hard or soft body. The factors which control these aspects of acceptability are:

- The bending strength of the frame
- The height of the frame
- The thickness of the plasterboards
- The number of plasterboard layers.
- The rigidity of the head fixing
- The spacing of the studs
- The axial load (if any) from above
- The wind load - uniformly distributed load (UDL) if any
- Any temporary point load (if any) at mid height
- The stiffness of the plasterboards
- The hardness of the plasterboards
- The bending/breaking strength of the plasterboards

It is not possible to write a mathematical equation which takes into account all these factors and which, when the physical properties of the materials are used to calculate, for example, height limit, gives a satisfactory relationship to practical acceptability.

Instead, over the years, plasterboard manufacturers have built up a dossier of knowledge which relates the main parameters to the acceptability of known generic systems. There is also a nucleus of testing data, to fall back upon, where this acceptability is in doubt.

The 5 main tests are:

- Stiffness - 500 N temporary pressure
- Small hard body impact - 5 kg swing hammer
- Large soft body impact - 50 kg swinging bag
- UDL and crowd pressure - 2.5m beam pressure
- Door slamming - 20 slams, 35 kg door for LD and MD
- 100 slams, 60 kg door for HD and SD

From these tests it is possible to judge whether the partition is graded as:

- Light duty LD
- Medium duty MD
- Heavy duty HD
- Severe duty SD

The duty ratings for partitions are shown in the tables of performance, in subsequent chapters of this Technical Manual.

TABLE 3: PERFORMANCE TABLES PARTITION GRADES:

SUMMARY OF REQUIREMENTS AND PRINCIPLE TEST PERFORMANCE LEVELS AS PER BS 5234

REQUIREMENT & TEST METHOD (1)	UNITS	GRADE ¹				PRINCIPAL CRITERIA
		LD	MD	HD	SD	
Stiffness (A)	mm	25	20	15	10	Maximum deflection
	mm	5	3	2	1	Maximum residual deformation
Small hard body impact: Surface damage (B)	N.m	3	3	6	10	Judgement of incident
Perforation (D)	N.m	2	5	15	30	No perforation on facing
Large soft body impact: Damage (C)	N.m	20	20	40	100	2mm maximum deflection
Structural Damage	N.m	60	60	120	120	No collapse or dislocation
Door slam	No.	20	20	100	100	No damage and 1mm maximum displacement

¹(LD): Light Duty, (MD): Medium Duty, (HD): Heavy Duty, (SD): Severe Duty

TABLE 4: DESIGN CRITERIA FOR MINIMUM SOUND ISOLATION PERFORMANCE BETWEEN ENCLOSED ROOMS¹

AS PER 2018 FGI GUIDELINES FOR DESIGN AND CONSTRUCTION OF HOSPITALS

Adjacency Combination		Acoustic Performance dB ²	USG Boral ME Wall Assembly commendation
Patient Care Units			
Patient Room	Corridor (with entrance)	35 ³	HCW1
Patient Room	Patient Room (wall-same floor)	45 ⁴	HCW1
Patient Room	Patient Room (floor-to-floor)	50	HCW2
Patient Room	Consultation Room	50	HCW2
Patient Room	Public Space	50	HCW2
Patient Room	Service Area	60 ⁵	HCW7
Patient Room	MRI Room	60 ⁵	HCW9
NICU Corridor	Corridor	55	HCW3
Diagnostic and Treatment Locations			
Examination Room	Corridor (with entrance)	35 ³	HCW1
Examination Room	Examination Room (with electronic masking)	40 ⁶	HCW1
Examination Room	Examination Room (no electronic masking)	50	HCW2
Examination Room	Public Space	50	HCW2
Examination Room	MRI Room	60 ⁵	HCW9
Treatment Room	Corridor (with entrance)	35 ³	HCW1
Treatment Room	Treatment Room	50	HCW4
Operating Room	Operating Room	50	HCW4
Operating Room	MRI Scanner Room	60 ^{5,7}	HCW9
Consultation Room	Public Space	50	HCW8
Consultation Room	Corridor (with entrance)	35 ³	HCW1
Public Areas			
Toilet Room	Public Space	45	HCW5
Public Space	MRI Scanner Room	50	HCW9

¹Additional spaces shall be added based on the building program.

²The Acoustic Performance values stated assume the need for normal speech privacy as shown in Table 2 (Design Criteria for Speech Privacy for Enclosed Rooms and Open-Plan Spaces)—except at corridor walls with doors—assuming a background sound level of at least 30 dB. When selecting assemblies based on their tested or published Acoustic Performance ratings, it should be noted that laboratory Acoustic Performance test reports can, in general, be considered accurate to +/- 2 Acoustic Performance points. Consequently, an assembly with a tested or published Acoustic Performance rating as low as 2 points below the stated minimum may be considered acceptable.

³In cases where greater speech privacy is required between patient care rooms when both room doors to the connecting corridor are closed, the composite demising wall Acoustic Performance requirement shall be 50.

⁴This is the performance required for the wall around the door. Note that sound isolation in these instances will be limited by the door's performance (e.g., Acoustic Performance 20 for a close-fitted 5-PSF door). It is up to the facility to determine if doors require a higher acoustic performance or if full perimeter gasketing and bottom seals should be required. Doors are not required to be sound sealed to maintain the Acoustic Performance rating, although a facility may choose to do so for specialty patient environments such as bereavement rooms, consultation rooms, sleep therapy rooms, etc.

⁵Relaxation of Acoustic Performance 60 ratings shall be permitted if compliance with room noise requirements is achieved with lower performance constructions. See Table 1 (Maximum Design Criteria for Noise in Interior Spaces Caused by Building Systems).

⁶Electronic masking shall provide a maximum background level of Acoustic Performance 48 dB.

⁷This requirement is for operating rooms without doors directly communicating with the MRI scanner room as the Acoustic Performance value shown cannot be achieved when there is a door between an adjacent OR and an MRI scanner room. However, where there is a connecting door, attention shall be paid to the door to assure sound isolation when the MRI is used independently from the operating room.

Note: This table shall not be applied to mobile/transportable medical units.

TABLE 5: RECOMMENDED PARTITION SOUND RATING FOR DIFFERENT PRIVACY REQUIREMENTS

Privacy Description	Partition Sound Rating
'Normal' Degree of Privacy Normal voices in adjacent space audible and intelligible some of the time. Raised voices and speakerphones mostly intelligible.	45 dB Acoustic Performance
'Good' Degree of Privacy Normal voices in adjacent space barely audible but unintelligible most of the time. Raised voices and speakerphones partially intelligible.	50 dB Acoustic Performance
'Excellent' Degree of Privacy Normal voices in adjacent space mostly inaudible. Raised voices and Speakerphones audible but intelligible some of the time.	55 dB Acoustic Performance
'Confidential' Degree of Privacy Normal voices in adjacent space are not audible. Raised voices and Speakerphones are barely audible but not intelligible.	60 dB+ Acoustic Performance



TABLE 6: MINIMUM RECOMMENDED LEVELS OF AIRBORNE SOUND INSULATION BETWEEN SPACES

Table shows recommended levels of airborne sound insulation based on noise activity in the source room and acceptable noise tolerance levels in the receiving room.

		Noise generation in source room			
		low noise	typical noise	high noise	very high noise
		low noise	typical noise	high noise	very high noise
Clean Utility, Store Rooms, Laboratories/Study Areas	non sensitive tolerance	35	40	45	50
		30	35	40	45
		40	50	50	60
		35	45	45	55
Libraries/Study Areas, Multi Bed Wards, Operating Theatres, Toilets, Private Offices, Children's Multi Bed Wards, Geriatric Multi Bed Wards, Rest Rooms	moderate tolerance	45	50	55	60
		40	45	50	55
		50	50	55	60
		45	45	50	55
Single Bed Wards/On Call Rooms, Consulting Rooms, Treatment Rooms, Small Meeting Rooms, Children's Single Wards, Geriatric Single Wards, Training Rooms, Board Room/Large Meeting Rooms, Nurseries, Delivery Rooms	private tolerance	50	50	55	60
		45	45	50	55
		55	55	55	60
		50	50	55	60
Lecture Theatres	confidential tolerance	50	50	55	60
		45	45	50	55
		55	55	55	60
		50	50	55	60

Note: It is important to check values from both rooms and use the highest value.

The information provided is intended to enable designers, architects and specifiers to select partitions which meet the acoustic requirements having made some general assumptions. USG Boral ME strongly recommend that a qualified acoustic consultant be appointed to check all acoustic specifications and details.

HOSPITAL EXTERIOR FINISHING

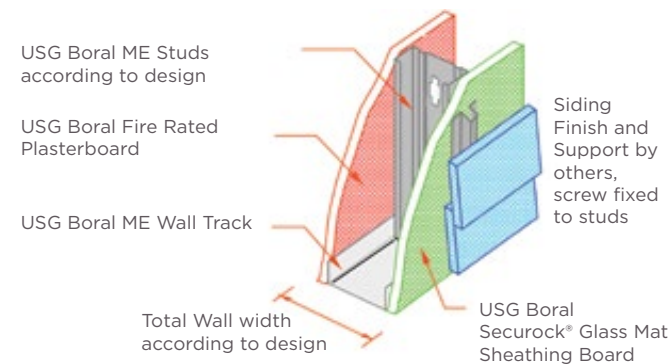
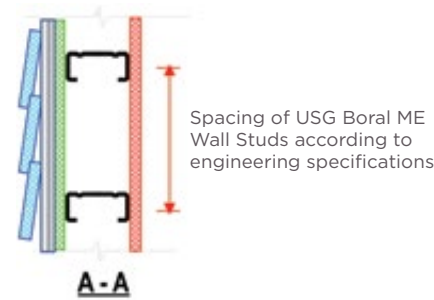
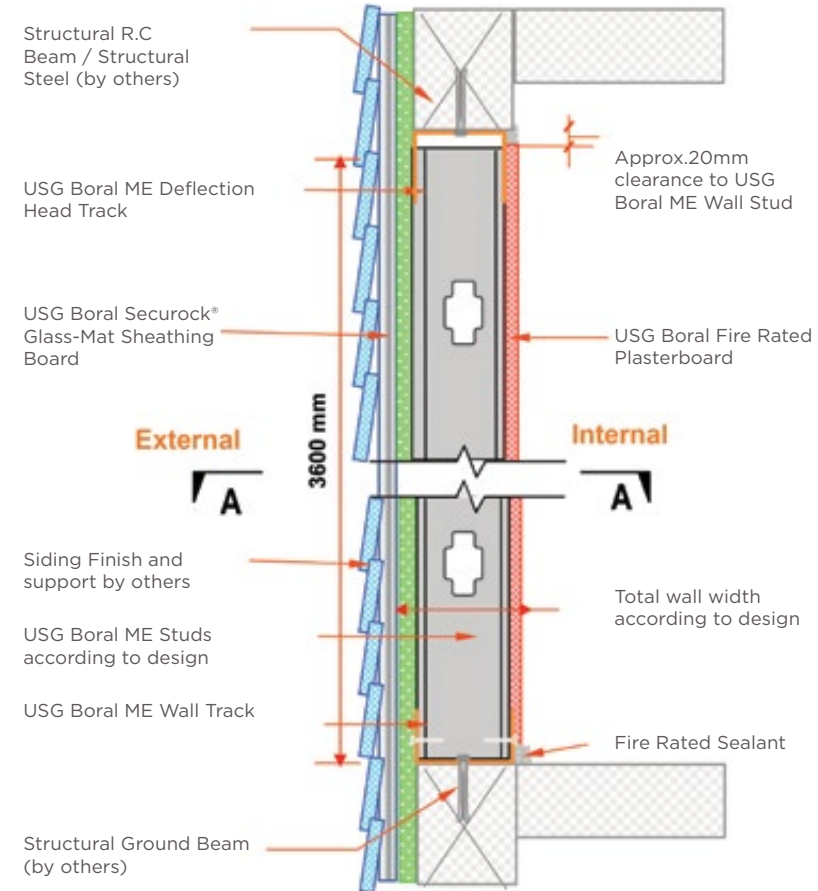

Note: USG Boral Securock® Brand Glass-Mat Sheathing panels can be used to form a fire-rated partition.

HCEW1

DIRECT-APPLIED EXTERIOR FINISHING SYSTEM

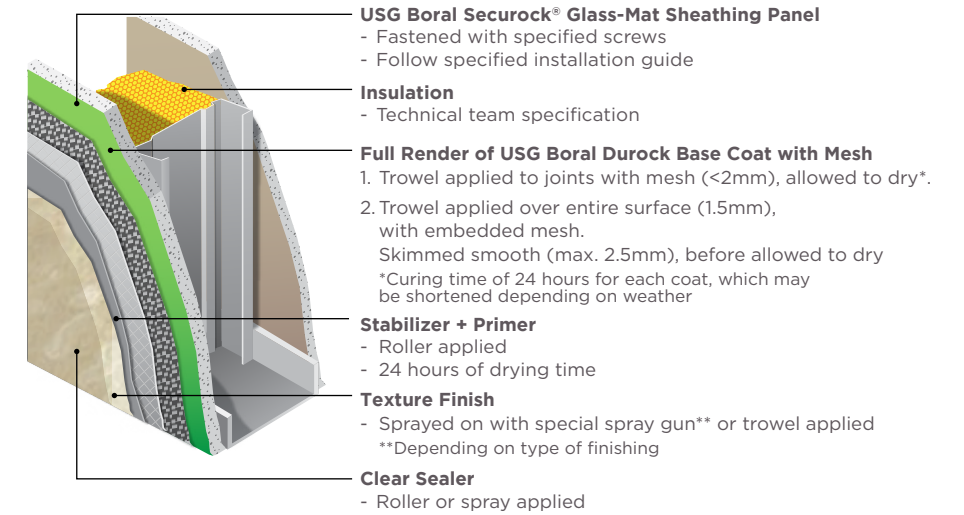

HCEW2

METAL PANEL FACADE FINISHING SYSTEM

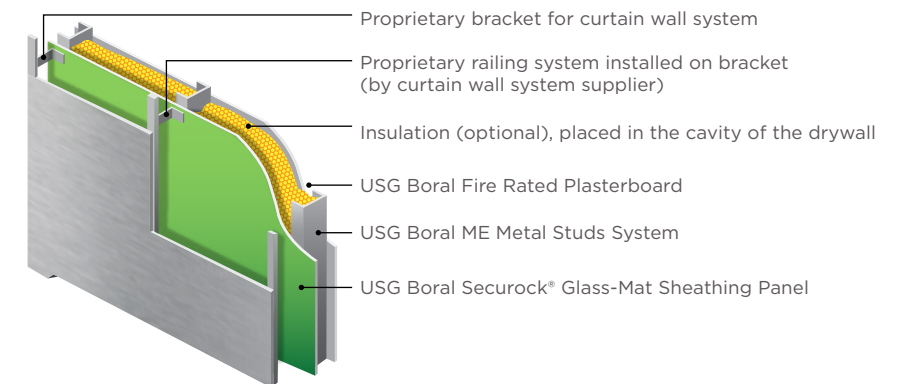

HCEW3

EIFS SYSTEMS (EPS, PIR, NEO INSULATION BOARD)

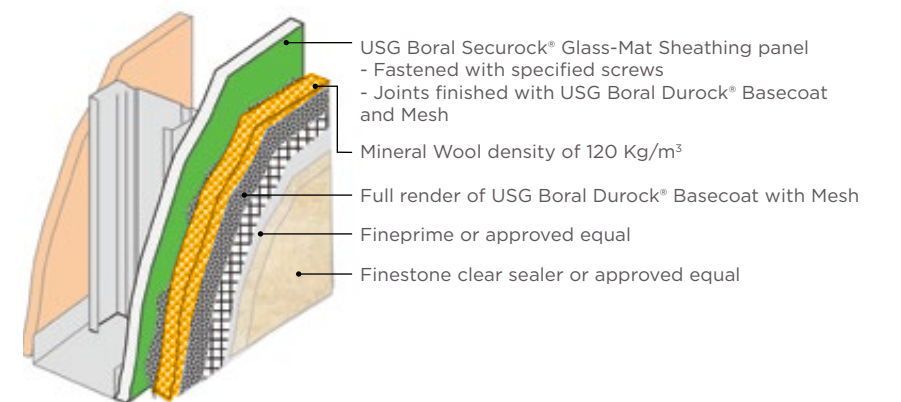

HCW1

PATIENT ROOM TO PATIENT ROOM (WALL-SAME FLOOR) EXAM ROOM TO EXAM ROOM (WITH ELECTRONIC MASKING)

1 HOUR FIRE RATED
ASSEMBLY UL U 419
47 dB

Fire Rating	1 hour
Acoustic Performance	47 dB
System Thickness	96mm

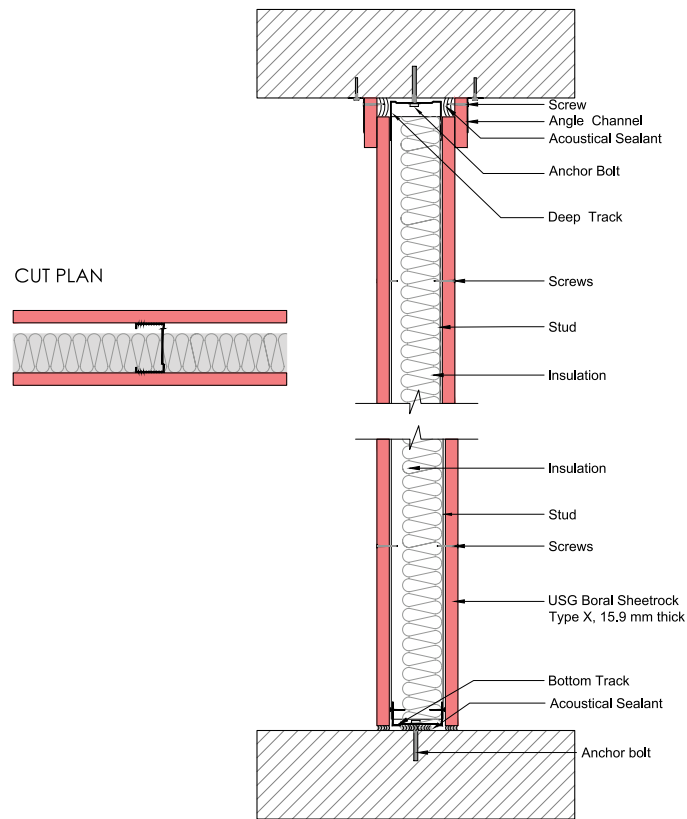
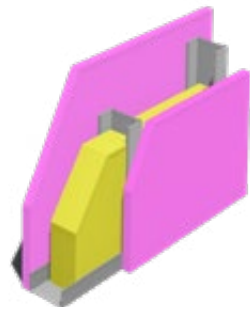

WALL CONSTRUCTION

Gypsum Board : One layer of 5/8" (15.9mm) thick USG Boral Sheetrock® brand Type X Gypsum Board applied horizontally or vertically

Steel Studs : 62.5mm C-Stud spaced at 600mm OC

Steel Tracks : Top Track: 64x50mm deep U-track
Bottom Track: 64x30mm U-track

Insulation: 50mm thick Mineral Wool insulation (Density 14 kg/m³)

Gypsum Board : One layer of 5/8" (15.9mm) thick USG Boral Sheetrock® brand Type X Gypsum Board applied horizontally or vertically

Joint Compound : USG Boral Sheetrock® Brand All-Purpose Joint Compound

Acoustical Sealant: USG Sheetrock® Brand Acoustical Sealant

Tapes: USG Sheetrock® Brand Paper Tape

Screws : First layer: 4.2 x 32mm Screw, Bugle Head – Self Drilling

Level 5 finish : Sheetrock® Tuff-Hide® Primer-Surfacer

Steel Studs and Steel Tracks Thicknesses as per design requirements.

Deflection head as per design requirements.

HCW2

PATIENT ROOM TO PATIENT ROOM (FLOOR-TO-FLOOR) EXAM ROOM TO EXAM ROOM (NO ELECTRONIC MASKING)

2 HOURS FIRE RATED
ASSEMBLY UL U 419
56 dB

Fire Rating	2 hours
Acoustic Performance	56 dB
System Thickness	136mm

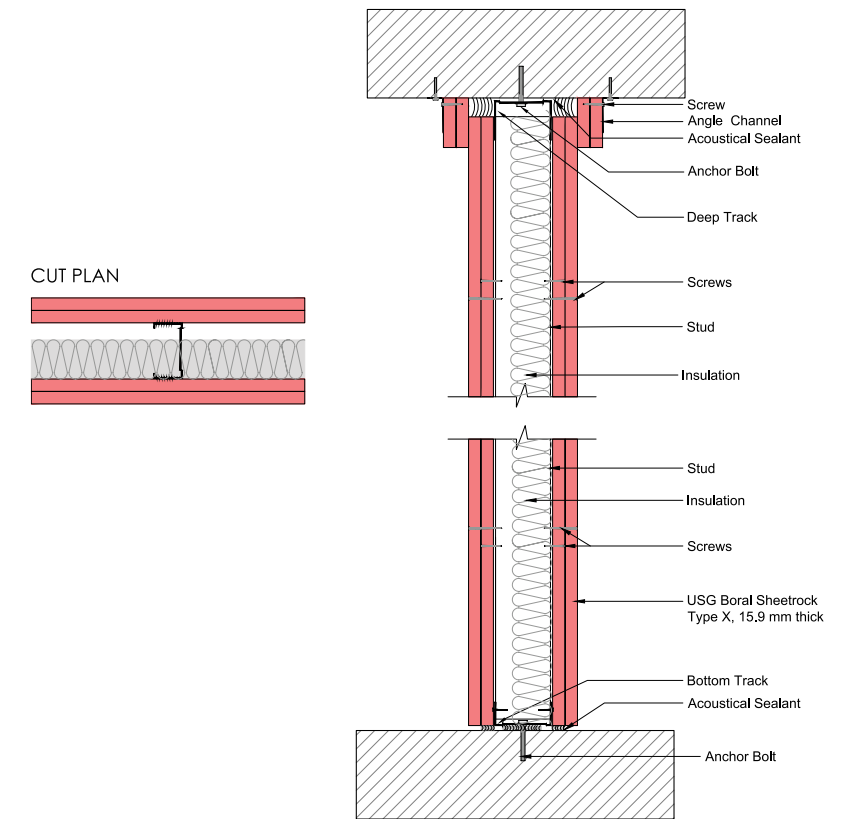

WALL CONSTRUCTION

Gypsum Board : Two layers of 5/8" (15.9mm) thick USG Boral Sheetrock® brand Type X Gypsum Board applied horizontally or vertically

Steel Studs : 70.5mm C-Stud spaced at 600mm OC

Steel Tracks : Top Track: 72x50mm deep U-track
Bottom Track: 72x30mm U-track

Insulation : 50 mm Mineral Wool (Density 14 kg/m³)

Gypsum Board : Two layers of 5/8" (15.9mm) thick USG Boral Sheetrock® brand Type X gypsum board applied horizontally or vertically

Joint Compound : USG Boral Sheetrock® Brand All-Purpose Joint Compound

Acoustical Sealant : USG Sheetrock® Brand Acoustical Sealant

Tapes : USG Sheetrock® Brand Paper Tape

Screws : First layer: 4.2 x 32mm Screw, Bugle Head – Self Drilling
Second Layer : 4.2 x 50mm Screw, Bugle Head – Self Drilling

Level 5 finish : Sheetrock® Tuff-Hide® Primer-Surfacer

Steel Studs and Steel Tracks Thicknesses as per design requirements.

Deflection head as per design requirements.

HCW3

2 HOURS FIRE RATED
ASSEMBLY UL U 419
55 dB



NICU TO CORRIDOR

Fire Rating	2 hours
Acoustic Performance	55 dB
System Thickness	156mm

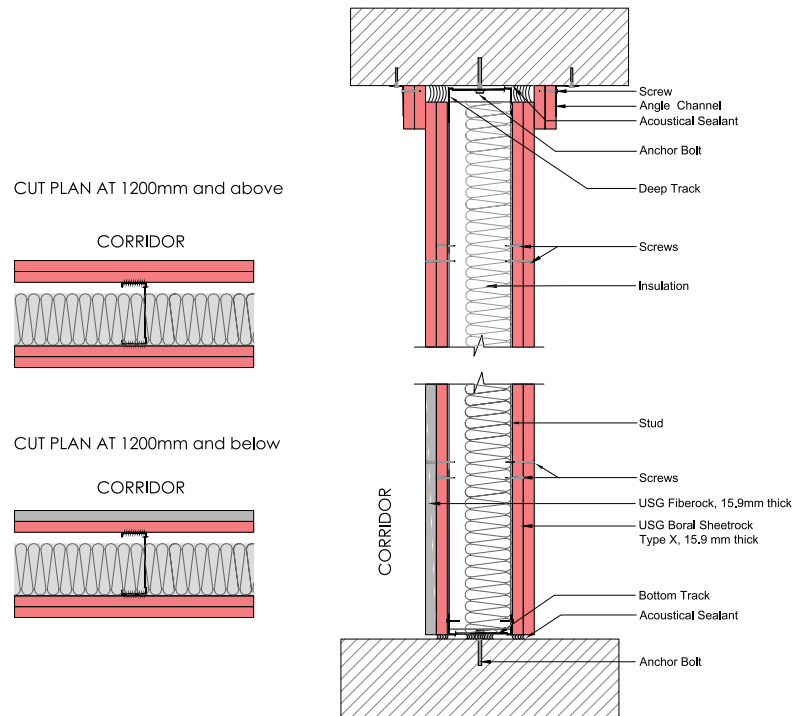

Inner Layer : One layer of 5/8" (15.9mm) thick USG Boral Sheetrock® brand Type X gypsum board applied horizontally or vertically

Outer Layer : 1 layer of USG Fiberock® 5/8" (15.9mm) thick board (Impact resistant) applied horizontally on the bottom of corridor's side 1200 mm from floor

Gypsum Board above Fiberock®: One Layer of 5/8" (15.9mm) thick USG Boral Sheetrock® brand Type X gypsum board applied horizontally or vertically

Steel Studs : 90.5mm C-Stud spaced at 600mm OC

Steel Track : Top Track: 92x50mm deep U-track
Bottom Track: 92x30mm U-track

Insulation : 75mm thick Mineral Wool insulation (Density 14 kg/m³)

Gypsum Board : Two layers of 5/8" (15.9mm) thick USG Boral Sheetrock® brand Type X gypsum board applied horizontally or vertically

Joint Compound : USG Boral Sheetrock® Brand All-Purpose Joint Compound for Type X Gypsum Board and USG Durabond® for Fiberock® joint finishing

Acoustical Sealant : USG Sheetrock® Brand Acoustical Sealant

Tapes : USG Sheetrock® Brand Paper Tape

Screws : First layer: 4.2 x 32mm Screw, Bugle Head – Self Drilling
Second Layer : 4.2 x 50mm Screw, Bugle Head – Self Drilling

Level 5 finish : Sheetrock® Tuff-Hide® Primer-Surfacer

Steel Studs and Steel Tracks Thicknesses as per design requirements.

Deflection head as per design requirements.

WALL CONSTRUCTION

HCW4

2 HOURS FIRE RATED
ASSEMBLY UL U 419
55 dB

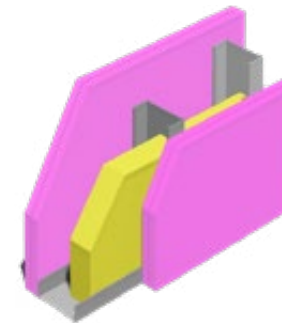

TREATMENT ROOM TO TREATMENT ROOM OPERATING ROOM TO OPERATING ROOM

Fire Rating	2 hours
Acoustic Performance	55 dB
System Thickness	143mm

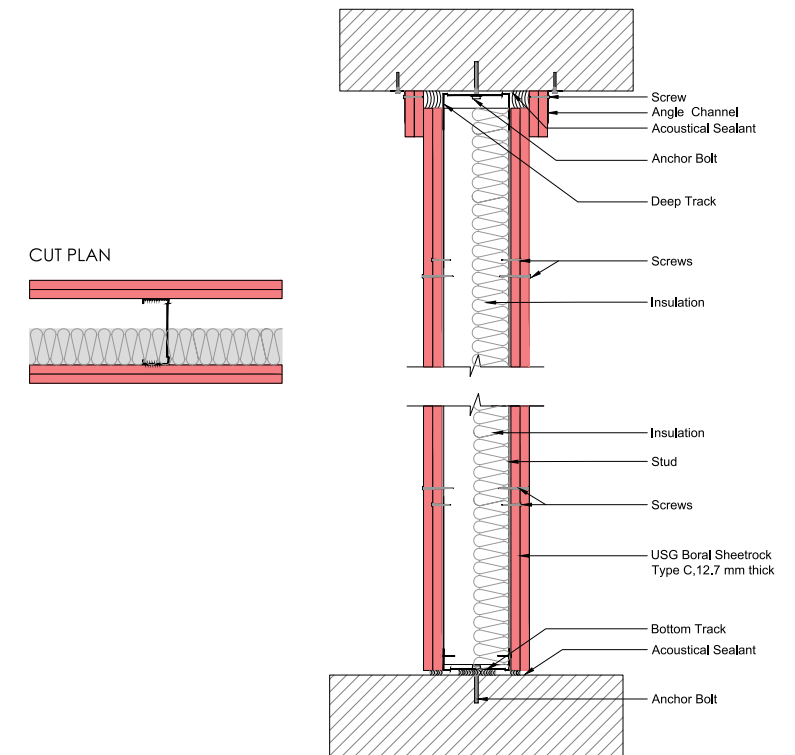

Gypsum Board : Two layers of 1/2" (12.7mm) USG Boral Sheetrock® brand Type C gypsum board applied horizontally or vertically

Steel Studs : 90.5mm C-Stud spaced at 600mm OC

Steel Tracks : Top Track: 92x50mm deep U-track
Bottom Track: 92x30mm U-track

Insulation : 50mm thick Mineral Wool insulation (Density 14 kg/m³)

Gypsum Board : Two layers of 1/2" (12.7mm) USG Boral Sheetrock® brand Type C gypsum board applied horizontally or vertically

Joint Compound : USG Boral Sheetrock® Brand All-Purpose Joint Compound

Acoustical Sealant : USG Sheetrock® Brand Acoustical Sealant
Tapes: USG Sheetrock® Brand Paper Tape

Screws : First layer: 4.2 x 32mm Screw, Bugle Head – Self Drilling
Second Layer : 4.2 x 50mm Screw, Bugle Head – Self Drilling

Level 5 finish : Sheetrock® Tuff-Hide® Primer-Surfacer

Steel Studs and Steel Tracks Thicknesses as per design requirements.

Deflection head as per design requirements.

WALL CONSTRUCTION

HCW5

1 HOUR FIRE RATED
ASSEMBLY UL U 419
50 dB

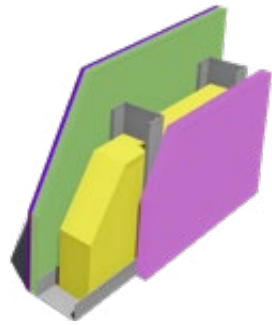

TOILET ROOM TO PUBLIC SPACE

Fire Rating	1 hour
Acoustic Performance	50 dB
System Thickness	110mm

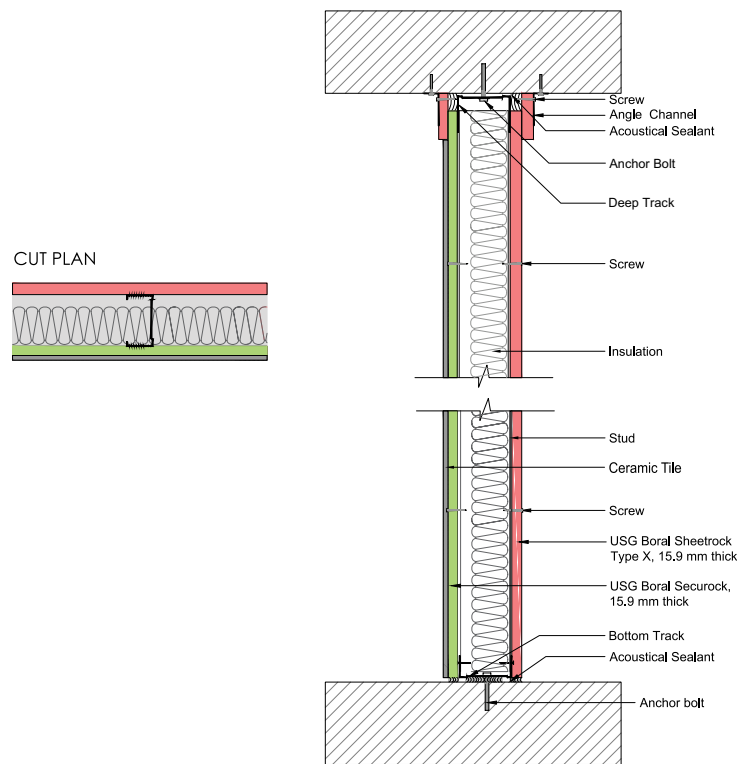

WALL CONSTRUCTION

Gypsum Board : One layer of 5/8" (15.9mm) thick USG Boral Sheetrock® brand Type X gypsum board applied horizontally or vertically¹

Steel Studs : 70.5mm C-stud spaced at 600mm o.c

Steel Track : Top Track: 72x50mm deep U-track
Bottom Track: 72x30mm U-track

Insulation: 50mm thick Mineral Wool insulation (Density 14 kg/m³)

Substrate Layer: One layer of 5/8" (15.9mm) USG Boral Securock® brand Type X with 6.4mm thick Ceramic Tile on opposite side.

Joint Compound : USG Boral Sheetrock® Brand All-Purpose Joint Compound

Base Coat : USG Boral Durock® Base Coat

Acoustical Sealant : USG Sheetrock® Brand Acoustical Sealant

Tapes : USG Sheetrock® Brand Paper Tape & USG 2" Interior Durock® tape

Screws : Gypsum layer: 4.2 x 32mm Screw, Bugle Head – Self Drilling & (1-1/4") 32mm Durock® Screw

Level 5 finish : Sheetrock® Tuff-Hide® Primer-Surfacer

¹Additional board of 5/8 (15.9mm) thick USG Boral Sheetrock® brand Type X gypsum is required on the public space side to achieve the severe duty performance.

Steel Studs and Steel Tracks Thicknesses as per design requirements.

Deflection head as per design requirements.

HCW6

1 HOUR FIRE RATED
ASSEMBLY UL U 419
47 dB

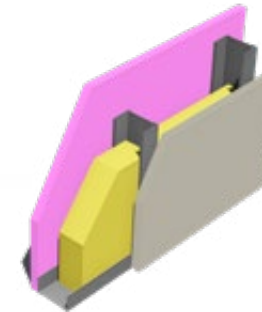

WALL CONSTRUCTION

PATIENT ROOM TO CORRIDOR (WITH ENTRANCE) CONSULTATION ROOM TO CORRIDOR (WITH ENTRANCE)

Fire Rating	1 hour
Acoustic Performance	47 dB
System Thickness	96mm

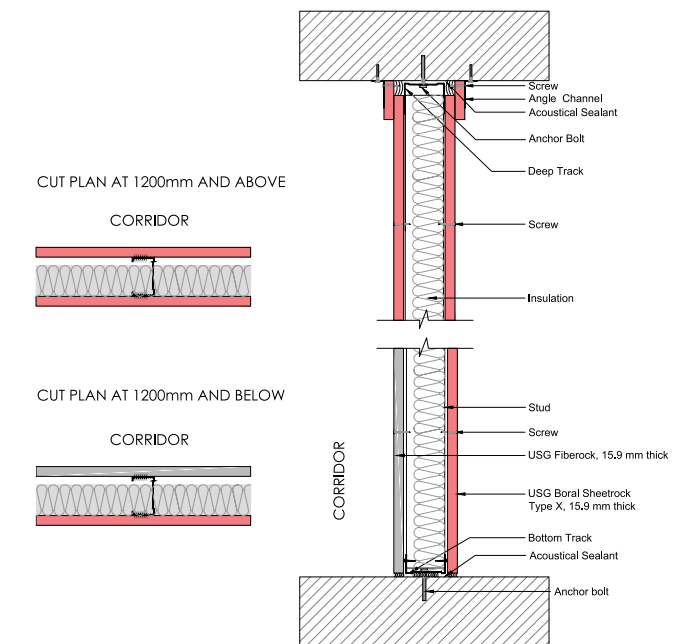

Outer Layer : One layer of USG Fiberock® 5/8" (15.9mm) thick board (Impact resistant) applied horizontally on the bottom of corridor's side 1200mm from floor

Gypsum Board above Fiberock® : One layer of 5/8" (15.9mm) thick USG Boral Sheetrock® brand Type X gypsum board applied horizontally or vertically¹

Steel Studs : 62.5mm C-Stud spaced at 600mm OC

Steel Track : Top Track: 64x50mm deep U-track
Bottom Track: 64x30mm U-track

Insulation : 50mm thick Mineral Wool insulation (Density 14 kg/m³)

Gypsum Board : One layer of 5/8" (15.9mm) thick USG Boral Sheetrock® brand Type X gypsum board applied horizontally or vertically¹

Joint Compound : USG Boral Sheetrock® Brand All-Purpose Joint Compound for Type X Gypsum Board and USG Durabond® for Fiberock® joint finishing

Acoustical Sealant : USG Sheetrock® Brand Acoustical Sealant

Tapes : USG Sheetrock® Brand Paper Tape

Screws : First layer: 4.2 x 32mm Screw, Bugle Head – Self Drilling

Level 5 finish : Sheetrock® Tuff-Hide® Primer-Surfacer

¹Additional board of 5/8 (15.9mm) thick USG Boral Sheetrock® brand Type X gypsum is required on the corridor side to achieve the severe duty performance.

Steel Studs and Steel Tracks Thicknesses as per design requirements.

Deflection head as per design requirements.

HCW7

2 HOURS FIRE RATED
ASSEMBLY
61 dB

PATIENT ROOM TO SERVICE AREA

Fire Rating	2 hours
Acoustic Performance	61 dB
System Thickness	169mm

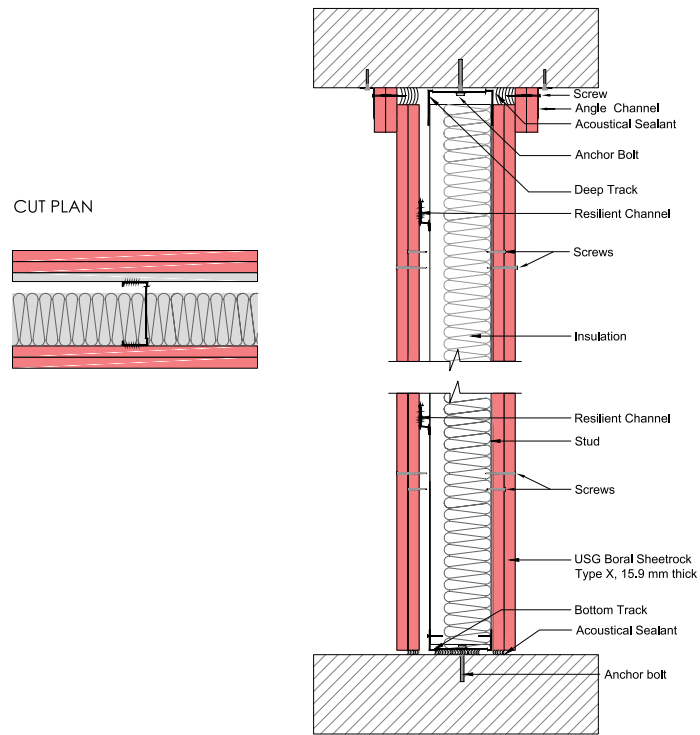
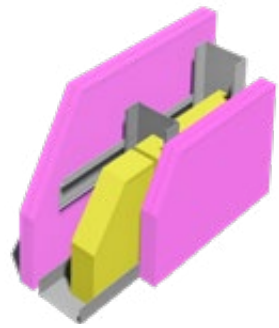

WALL CONSTRUCTION

Gypsum Board : Two layers of 5/8" (15.9mm) thick USG Boral Sheetrock® brand Type X gypsum board applied horizontally or vertically

Steel Studs : 90.5mm thick C-Stud spaced at 600mm OC

Steel Track : : Top Track: 92x50mm deep U-track
Bottom Track: 92x30mm U-track

Insulation : 75mm thick mineral wool insulation Density (14 kg/m³)

Resilient Channel : 13mm deep Resilient channel spaced at 600mm horizontally

Gypsum Board : Two layers of 5/8" (15.9mm) thick USG Boral Sheetrock® brand Type X gypsum board applied horizontally or vertically

Joint Compound : USG Boral Sheetrock® Brand All-Purpose Joint Compound

Acoustical Sealant : USG Sheetrock® Brand Acoustical Sealant

Tapes : USG Sheetrock® Brand Paper Tape

Screws: First layer: 4.2 x 32mm Screw, Bugle Head - Self Drilling
Second Layer : 4.2 x 50mm Screw, Bugle Head - Self Drilling

Level 5 finish : Sheetrock® Tuff-Hide® Primer-Surfacer

Steel Studs and Steel Tracks Thicknesses as per design requirements.

Deflection head as per design requirements.

HCW8

2 HOURS FIRE RATED
ASSEMBLY UL U 419
50 dB



OUT-PATIENT/CONSULTATION ROOM TO PUBLIC SPACE

Fire Rating	2 hours
Acoustic Performance	50 dB
System Thickness	156mm

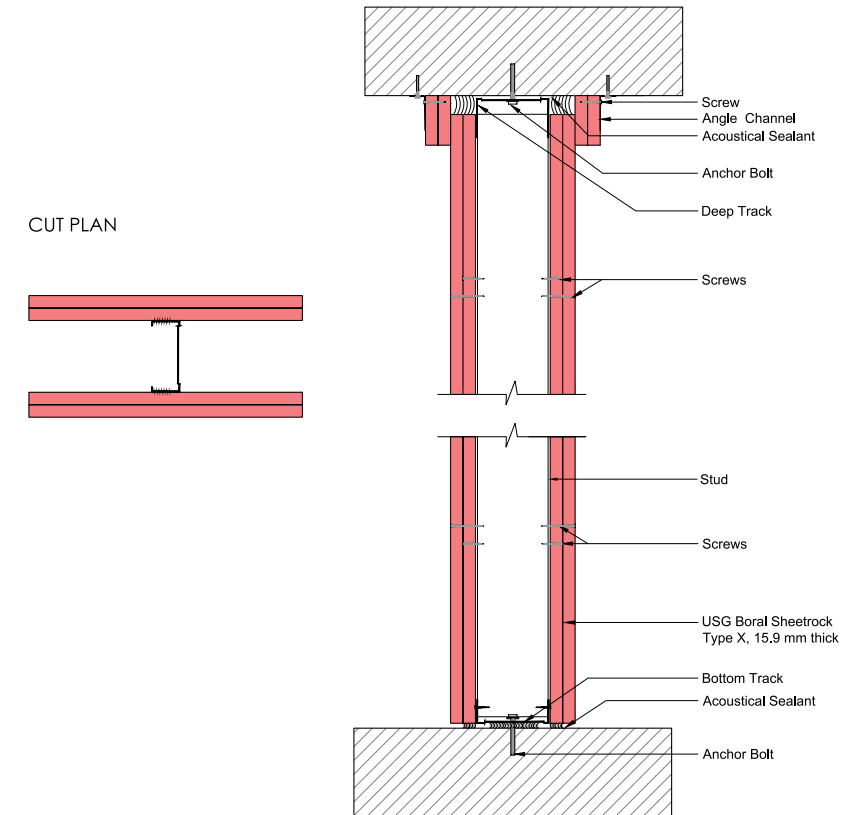

WALL CONSTRUCTION

Gypsum Board : Two layers of 5/8" (15.9mm) thick USG Boral Sheetrock® brand Type X gypsum board applied horizontally or vertically

Steel Studs : 90.5mm thick C-Stud spaced at 600mm OC

Steel Track : : Top Track: 92x50mm deep U-track
Bottom Track: 92x30mm U-track

Gypsum Board : Two layers of 5/8" (15.9mm) thick USG Boral Sheetrock® brand Type X gypsum board applied horizontally or vertically

Joint Compound : USG Boral Sheetrock® Brand All-Purpose Joint Compound

Acoustical Sealant : USG Sheetrock® Brand Acoustical Sealant

Tapes : USG Sheetrock® Brand Paper Tape

Screws : First layer: 4.2 x 32mm Screw, Bugle Head - Self Drilling
Second Layer: 4.2 x 50mm Screw, Bugle Head - Self Tapping

Level 5 finish : Sheetrock® Tuff-Hide® Primer-Surfacer

Steel Studs and Steel Tracks Thicknesses as per design requirements.

Deflection head as per design requirements.

HCW9

2 HOURS FIRE RATED
ASSEMBLY UL BE U 430
60 dB

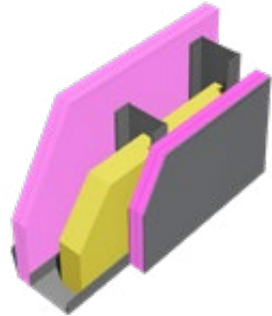

OPERATING ROOM TO MRI ROOM PATIENT ROOM TO MRI ROOM

Fire Rating	2 hours
Acoustic Performance	60 dB
System Thickness	158mm

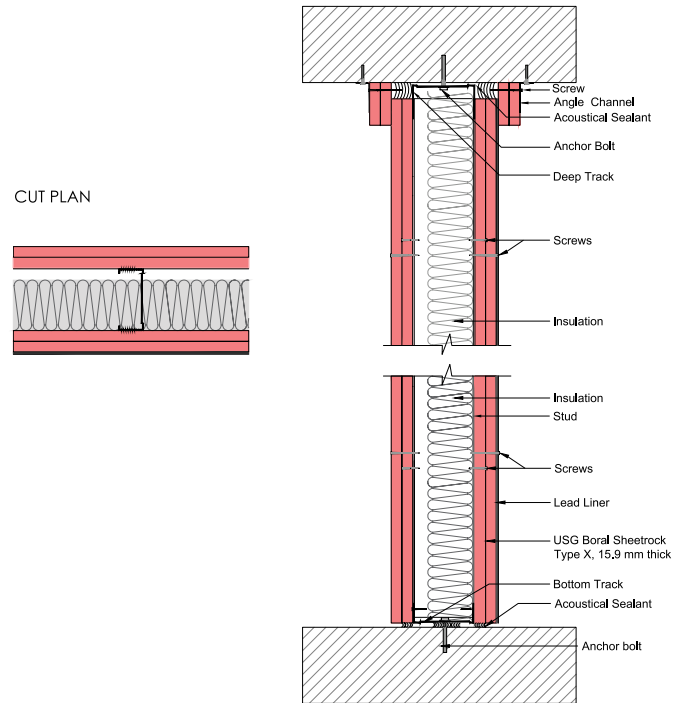

WALL CONSTRUCTION

- Gypsum Board :** Two layers of 5/8" (15.9mm) thick USG Boral Sheetrock® brand Type X gypsum board applied horizontally or vertically
- Steel Studs :** 90.5mm C-Stud spaced at 600mm OC
- Steel Track :** Top Track: 92x50mm deep U-track
Bottom Track: 92x30mm U-track
- Insulation:** 75mm thick Mineral Wool insulation (Density 14kg /m³)
- Gypsum Board :** 1 layer of 5/8" (15.9mm) thick USG Boral Sheetrock® brand Type X gypsum board applied horizontally or vertically
- Lead Lined Gypsum Board- RAY-BAR ENGINEERING CORP :** Type RBLBG using 5/8" (15.9mm) USG Sheetrock® type X board to be used with Lead Batten Strips or Lead Discs or Tabs as per UL BE U430. Minimum of lead thickness 2.5mm
- Joint Compound :** USG Boral Sheetrock® Brand All-Purpose Joint Compound
- Acoustical Sealant :** USG Sheetrock® Brand Acoustical Sealant
- Tapes :** USG Sheetrock® Brand Paper Tape
- Screws :** First layer: 4.2 x 32mm Screw, Bugle Head - Self Drilling
Second Layer: 4.2 x 50mm Screw, Bugle Head - Self Drilling
- Level 5 finish :** Sheetrock® Tuff-Hide® Primer-Surfacer

Steel Studs and Steel Tracks Thicknesses as per design requirements.

Deflection head as per design requirements.

HCSW1

2 HOURS FIRE RATED
ASSEMBLY UL U 415
50 dB

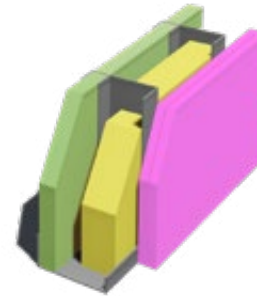

WALL CONSTRUCTION

SHAFTWALL STEEL COMPONENTS

SHAFTWALL SYSTEM

Fire Rating	2 hours
Acoustic Performance	50 dB
System Thickness	127mm

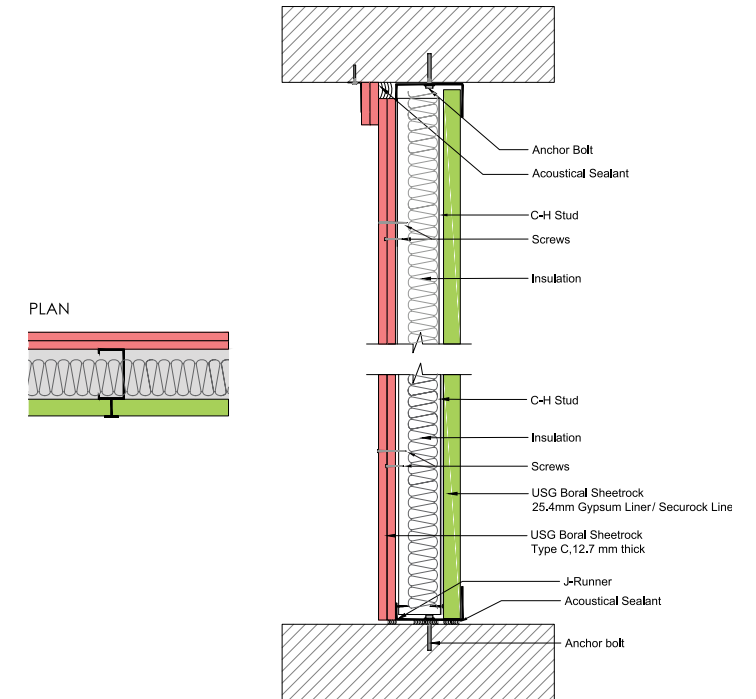

- Gypsum Board :** Two layers of 1/2" (12.7mm) thick USG Boral Sheetrock® brand Type C gypsum board applied horizontally or vertically
- CH-Stud :** 4" (101.6mm) x 0.9mm thick CH-Stud spaced at 600mm OC
- E-Stud :** 4" (101.6mm) x 0.9 mm thick E-Stud installed at corners
- J-Runner :** 4" (101.6mm)x0.9 mm thick J-Runner installed at top and bottom
- Insulation :** 75mm thick Mineral Wool insulation (Density 14kg /m³)
- Gypsum Board :** One layer of 1" (25.4mm) thick USG Boral Sheetrock® brand Gypsum Liner or Securock Liner® friction fit
- Joint Compound :** USG Boral Sheetrock® Brand All-Purpose Joint Compound
- Acoustical Sealant:** USG Sheetrock® Brand Acoustical Sealant
- Tapes :** USG Sheetrock® Brand Paper Tape
- Screws :** First layer: 4.2 x 32mm Screw, Bugle Head - Self Drilling
Second Layer: 4.2 x 50mm Screw, Bugle Head - Self Drilling
- Level 5 finish :** Sheetrock® Tuff-Hide® Primer-Surfacer

Deflection head as per design requirements.

CH Stud Sizes	J Runner Size	E Stud Sizes
63.5MM, 101.6MM, 152.4MM	63.5MM, 101.6MM, 152.4MM	63.5MM, 101.6MM, 152.4MM

HEALTHCARE CEILINGS FINISHES



TABLE 7: HEALTHCARE CEILING REQUIREMENTS

AS PER 2018 FGI GUIDELINES FOR DESIGN AND CONSTRUCTION OF HOSPITALS

Room Type	Requirement	Room
General Areas	<ul style="list-style-type: none"> Cleanable with routine housekeeping equipment Acoustic & lay-in ceilings shall not have ledges or crevices 	All rooms except as noted below
Semi-restricted Areas	<ul style="list-style-type: none"> Smooth and without crevices Scrubbable Water repellent Non-perforated Capable of withstanding cleaning with chemicals Lay-in ceilings shall be gasketed or each tile should weigh at least one pound per square foot Perforated, reveal, serrated, or highly textured tiles shall not be permitted 	Procedure rooms, Class 2 imaging rooms, endoscope processing rooms, decontamination rooms, clean corridors, and central sterile supply
Restricted Areas	<ul style="list-style-type: none"> Monolithic construction Scrubbable Capable of withstanding cleaning and/or disinfecting chemicals All access openings shall be gasketed 	Operating rooms, Class 3 imaging rooms, sterile compounding and hazardous drug compounding pharmacies
Food & Nutrition Service & Laundry Areas	<ul style="list-style-type: none"> Either a sealed monolithic and scrubbable gypsum board ceiling or a lay-in ceiling Non-corrosive grid Smooth Scrubbable Water repellent Non-perforated Capable of withstanding cleaning with chemicals Each tile should weigh at least one pound per square foot NRC 0.80 or higher is recommended 	Food preparation, food storage, ware washing & laundry areas
Mechanical, Electrical, and Communication Rooms	Omission of suspended ceilings in these areas shall be permitted	Mechanical rooms, electrical rooms, communication rooms



TABLE 8: USG BORAL RECOMMENDED CEILING PRODUCTS

AS PER 2018 FGI GUIDELINES FOR DESIGN AND CONSTRUCTION OF HOSPITALS

Space	Room Type as per 2018 FGI Guidelines for Design and Construction of Hospitals	USG Boral ME Ceiling Recommendation
Lobbies	General Areas	Sonata Healthcare Halcyon Healthcare Louna Ensemble Monolithic Acoustical Gypsum
Waiting Areas	General Areas	
Corridors	General Areas	Metal Torsion Spring System Sonata Planks
Patient Rooms	General Areas	Sonata Healthcare Sparta Taiga Hygiene
Nurse's Stations	General Areas	
Laboratories	General Areas	Sonata Healthcare Halcyon Healthcare Taiga Hygiene Clean Room Non Perforated Metal Clip-In Plain
Class 1 MRI & Imaging Rooms	General Areas	
Pharmacies	General Areas	
Hydro-therapy Rooms	General Areas	Sparta Clean Room Non Perforated
ICU / NICU	General Areas	Halcyon Healthcare 38mm thick with AXCE Gasketed Grid
Treatment / Procedure Rooms	Semi-restricted Areas	Sonata Healthcare with AXCE Gasketed Grid Metal Torsion Spring System Plain Metal Clip-In Aluminum Plain Ensemble Monolithic Acoustical Gypsum
Class 2 MRI & Imaging Rooms	Semi-restricted Areas	
Endoscope Processing Rooms	Semi-restricted Areas	
Decontamination Rooms	Semi-restricted Areas	
Clean Corridors	Semi-restricted Areas	
Central Sterile Supply	Semi-restricted Areas	
Operation Theaters	Restricted Areas	Metal Torsion Spring System Metal Clip-In Aluminum Ensemble Monolithic Acoustical Gypsum
Class 3 MRI & Imaging Rooms	Restricted Areas	
Sterile Compounding Pharmacies	Restricted Areas	
Hazardous Drug Compounding Pharmacies	Restricted Areas	
Food Preparation	Food & Nutrition Service & Laundry Areas	Sonata Healthcare with AX Corrosive Resistant Grid Halcyon Healthcare with AXCE Gasketed Corrosive Resistant Grid Clean Room Non Perforated Metal Torsion Spring System Plain Metal Clip-In Aluminum Plain
Food Storage	Food & Nutrition Service & Laundry Areas	
Ware Washing	Food & Nutrition Service & Laundry Areas	
Laundry Areas	Food & Nutrition Service & Laundry Areas	

HCC1

ENSEMBLE™ MONOLITHIC ACOUSTICAL CEILING SYSTEM

DESCRIPTION

• **USG Boral Ensemble™ Monolithic Acoustical Ceiling System** is a lightweight, non-combustible, high acoustic seamless ceiling system consist of USG Boral Ensemble™ Brand Panels 12.5mm thick screw fixed to framing system and finished using USG Boral Ensemble Spray Applied Finish.

• USG Boral Ensemble™ Brand Panels 12.5mm thick

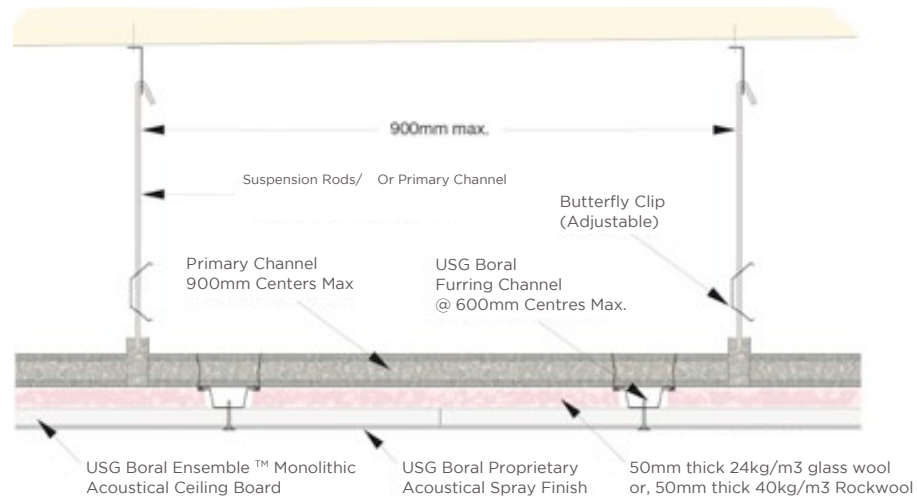

CEILING CONSTRUCTION

Lining: USG Boral Ensemble™ Brand Panels 12.5mm thick

Framing: USG Boral Primary Channel
USG Boral Furring Channel
USG Boral Wire Connecting Clip
USG Boral Primary Channel Bracket
USG Boral Butterfly Clip
USG Boral Suspension Rod

Insulation: as required

Fastener: 25mm Type 'S' Needle Point Screws

Joint Tape: USG Boral Paper Tape 50mm width

Jointing Compound: 1st and 2nd Coat : SHEETROCK® All Purpose Joint Compound or USG Boral Premium Premix
3rd Coat : SHEETROCK® Lightweight All-Purpose Joint Compound

Final Finish: USG Boral Ensemble Spray Applied Finish

To ensure the performance of this system meets the USG Boral Warranty requirements, only USG Boral products are to be used and installed correctly in accordance to USG Boral specifications and recommendations.

APPLICATION AS PER
2018 FGI GUIDELINES

- Central Sterile Supply
- Class 2 MRI & Imaging Rooms
- Class 3 MRI & Imaging Rooms
- Clean Corridors
- Decontamination Rooms
- Endoscope Processing Rooms
- Hazardous Drug Compounding Pharmacies
- Lobbies
- Operation Theaters
- Sterile Compounding Pharmacies
- Treatment / Procedure Rooms
- Waiting Areas

PERFORMANCE

Mass: 6.7 kg/m²

Acoustic rating : NRC 0.65 and α_w 0.70

Insulation : Glass wool 50mm thick 24kg/m³ or Rockwool 50mm thick 40kg/m³ both faced with back fleece

Light reflectance : 0.85

Fire rated: Class A

Finish: White, seamless, spray-applied fine texture with low VOC - emitting material

To ensure the performance of this system meets the USG Boral Warranty requirements, only USG Boral products are to be used and installed correctly in accordance to USG Boral specification and recommendations.

ARCHITECTURAL
SPECIFICATION

USG Boral Ensemble™ Monolithic Acoustical Ceiling System consist of USG Boral Ensemble™ Brand Panels 12.5mm thick screw fixed staggered onto USG Boral Dry Wall ceiling system (Primary Channel @ 900mm centers max., Furring Channel @ 600mm centers max., Suspension Bracket to connect rod and Primary Channel, 50mm thick 24kg/m³ glass wool or 50mm thick 40kg/m³ Rockwool insulation with back fleece placed on top of panels, board joints to be flush finished using USG Boral Paper Tape 50mm width and SHEETROCK® All Purpose Joint Compound or USG Boral Premium Premix (1st and 2nd coat) and SHEETROCK® Lightweight All-Purpose Joint Compound (3rd coat) jointing compound.

All board surface to be final finished with 2 - 3mm thick **USG Boral Ensemble Spray Applied Finish**, all fixed in accordance to manufacturer's instruction and recommendation.

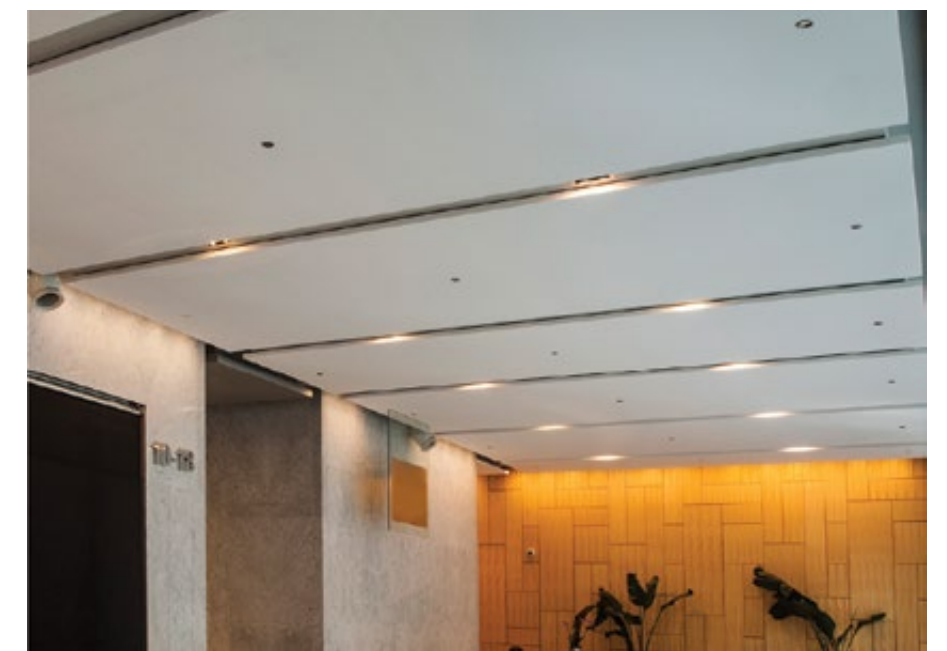

HCC2

METAL CEILING CLIP IN

STANDARD SPECIFICATION

RAL Colors



Wooden Finish



CLIP-IN CEILING SYSTEM

Features & Benefits:

- USG Boral ME offers a wide range of high quality metal panels that increase the aesthetic and functional value of your hospital interiors within relatively a modest ceiling budget.
- Clip-in Metal ceiling panels are all antibacterial tiles which are press formed from aluminum alloy series 3000 or mild steel in various RAL Colors or wooden textures
- Powder coating application having a coating thickness between 70-90 microns.
- Panel thickness ranges from 0.6 up to 1.4mm, other thickness is available upon request.
- Suspension components are made of galvanized steel or and prepainted steel/ Aluminum.

Applications as per 2018 FGI Guidelines:

- Central Sterile Supply
- Class 2 MRI & Imaging Rooms
- Class 3 MRI & Imaging Rooms
- Clean Corridors
- Corridors
- Decontamination Rooms
- Endoscope Processing Rooms
- Food Preparation
- Food Storage
- Hazardous Drug Compounding Pharmacies
- Laundry Areas
- Operation Theaters
- Pharmacies
- Sterile Compounding Pharmacies
- Ware Washing

TABLE 9: METAL CEILING CLIP IN SUSPENSION COMPONENTS

DESCRIPTION & MATERIAL	APPLICATION	
Suspension hanger	Suspends primary channel from soffit	
Suspension channel	Provides primary support and lateral restraint	
Spring tee bar (Triangle type)	Suspended profiles carry and hold adjacent clip-in tiles flanges	
Wire connecting clips	For fastening the Spring T into the primary channel	
Primary channel brackets	To suspend the primary channels using hangers	
Butterfly clip	Provide easy plenum height adjustment	
L-Trim	22 x 19.5mm - 0.48 thick	
U-Trim	30 x 50 x 30mm - 0.48 thick	

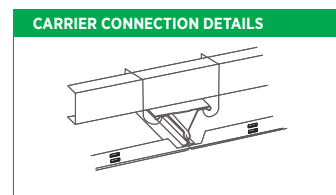
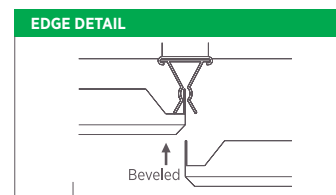

CUT VIEW DETAILS

PRODUCT INFORMATION

ITEM NO.	DESCRIPTION	TOTAL THICKNESS	EDGE DETAIL	COLOR	SUSPENSION OPTION
AC-11 (6)(7)(8) R (16)(10)(06)	Clip-in panel 300x300mm Alum, Plain	0.60/0.70/0.80mm	Beveled	RAL9016/9010/9006	Carrier Connection
AC-22 (6)(7)(8) R (16)(10)(06)	Clip-in panel 600x600mm Alum, Plain	0.60/0.70/0.80mm	Beveled	RAL9016/9010/9006	Carrier Connection
SC-22 (6)(7) R (16)(10)(06)	Clip-in panel 600x600mm Steel, Plain	0.50/0.60mm	Beveled	RAL9016/9010/9006	Carrier Connection
AC-14 (8)(9)(10) R (16)(10)(06)	Clip-in panel 300x1200mm Alum, Plain	0.80/0.90/1.0mm	Beveled	RAL9016/9010/9006	Carrier Connection
AC-15 (8)(9)(10) R (16)(10)(06)	Clip-in panel 300x1500mm Alum, Plain	0.80/0.90/1.0mm	Beveled	RAL9016/9010/9006	Carrier Connection
AC-24 (8)(9)(10) R (16)(10)(06)	Clip-in panel 600x1200mm Alum, Plain	0.80/0.90/1.0mm	Beveled	RAL9016/9010/9006	Carrier Connection
AC-44 (14) R (16)(10)(06)	Clip-in panel 1200x1200mm Alum, Plain	1.4mm	Beveled	RAL9016/9010/9006	Carrier Connection

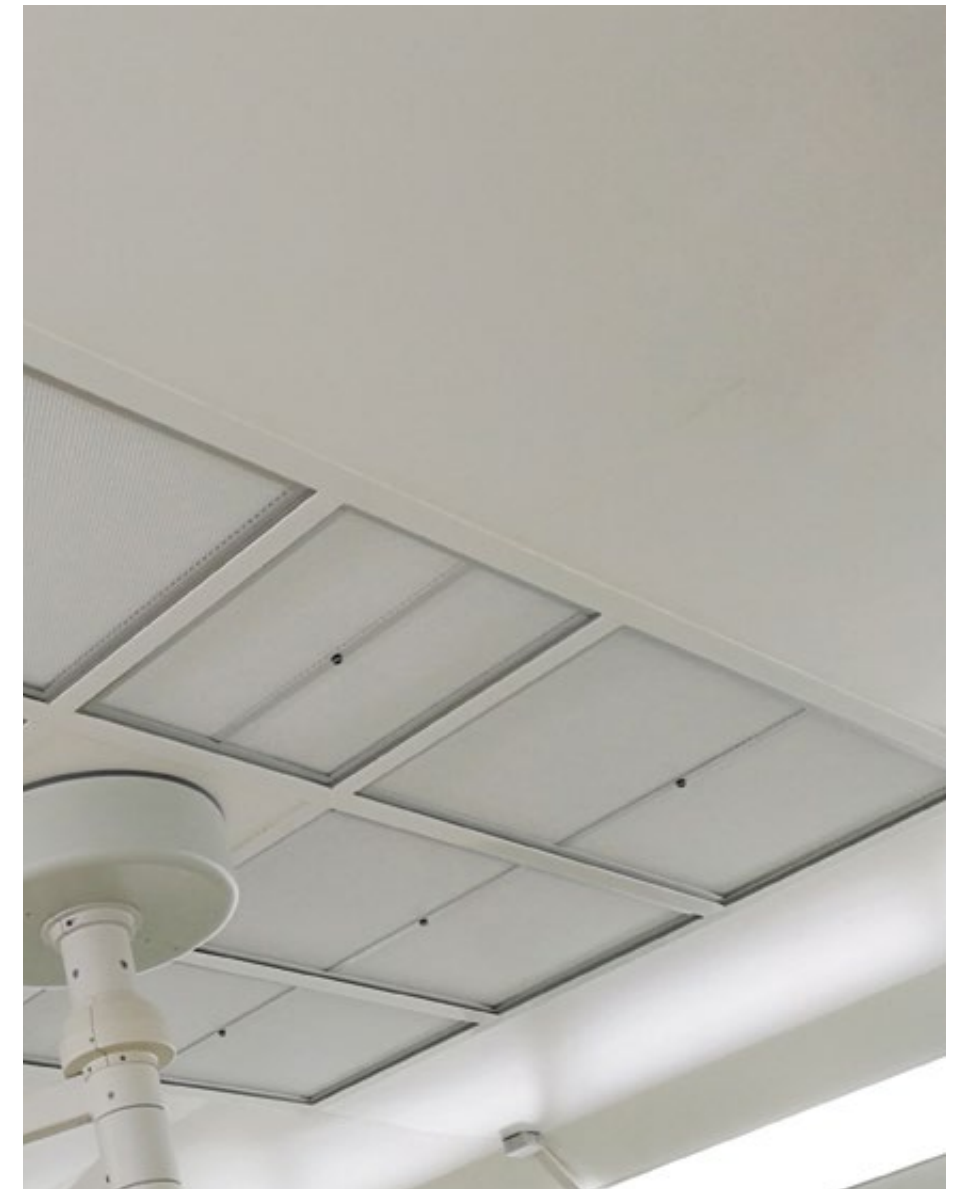

HCC3

METAL TORSION SPRING CEILING SYSTEM

STANDARD SPECIFICATION

Features & Benefits:

- Aluminum panels provide a monolithic appearance.
- Full 90-degree swing-down motion provides easy downward access to plenum areas.
- Spring clip design provides superior panel alignment.
- No reveal edges as its optimum solution for Operation room ceilings.
- Wind load tested and approved, including Miami-Dade NOA, for exterior applications with proper bracing and framing.

Applications as per 2018 FGI Guidelines:

- Central Sterile Supply
- Class 2 MRI & Imaging Rooms
- Class 3 MRI & Imaging Rooms
- Clean Corridors
- Corridors
- Decontamination Rooms
- Endoscope Processing Rooms
- Food Preparation
- Food Storage
- Hazardous Drug Compounding Pharmacies
- Laundry Areas
- Operation Theaters
- Operation Theaters
- Sterile Compounding Pharmacies
- Treatment / Procedure Rooms
- Ware Washing



PRODUCT SPECIFICATION DETAILS | ACOUSTICAL CEILINGS | 09 51 33

Panel Size (mm)	Panel Size (mm)	600x600	600x1200	600x1800	600x2400	1200x1200
Material thickness (mm)	Material thickness METRIC	0.8	0.8	1.0	1.0	1.0

General

Provide Acoustical Ceiling Material manufactured to meet requirements of this specification in accordance with ASTM E 1264

Materials

- Type: VII, aluminum facing (pan) with mineral glass or fiber base backing.
- Pattern: Plain
- Panel Face Finish: Standard colors is RAL 9010 and many other wooden patterns are Beech, Cherry, Maple, Walnut, Alder, Oak, Mahogany and Polaris, others are available upon request
- LR: It will vary depending on paint color
- NRC: It will vary depending on acoustical backer
- CAC: It will vary depending on acoustical backer
- Edge/Joint Detail: Butt Joint.
- Suspension Grid Width 24mm
- Panel Height : 38mm
- Modular Size: 600x600mm , 600x1200mm, 600x1800mm, 600x2400mm, 1200x1200mm
- Required accessories: Stabilizer bars for all panels longer than 1524mm
- Product Name: METAL TORSION SPRING CEILING SYSTEM

DIRECT-HUNG, METAL SUSPENSION SYSTEM FOR TORSION SPRING METAL PAN CEILING.

Wide-Face, Capped, Double-Web, Steel Suspension System: Main runners and Cross runners roll formed from cold-rolled steel sheet, prepainted, electrolytic zinc-coated or hot-dip galvanized according to ASTM A 653/A 653M, G30 (Z90) coating designation, with prefinished, cold-rolled, 24mm wide sheet metal caps on flanges.

SUSPENSION SYSTEM

A. DX MAIN TEE

- a. Structural Classification: Heavy-duty system.
- b. End Condition of Main Runners: Snap Clip.
- c. Face Design: Flat, flush.
- d. Cap Material: Steel cold-rolled sheet.
- e. Cap Finish: White.
- f. Grid Length: 3600mm

B. DX LONG CROSS TEE

- a. End Condition of Cross Runners: Snap Clip.
- b. Face Design: Flat, flush.
- c. Cap Material: Steel cold-rolled sheet.
- d. Cap Finish: White
- e. Grid Length: 1200mm

C. SHORT CROSS TEE

- a. End Condition of Cross Runners: Snap Clip.
- b. Face Design: Flat, flush with factory-cut slots fabricated to accept torsion-spring-hinged attachment.
- c. Cap Material: Steel cold-rolled sheet.
- d. Cap Finish: White
- e. Grid Length: 600mm

HCC4

CLEAN ROOM™ NON-PERFORATED

STANDARD
SPECIFICATION







Features & Benefits:

- Have an embossed, vinyl-laminated face with sealed back and edges for use in Class 100 (cross reference to Class 5 per ISO 14644-1) or 10M-100M clean rooms as per Federal standard 209E for Classification by Airborne particles
- Made with Fire code base materials to meet life safety codes
- Available in non-perforated finish for healthcare applications
- Classified HRC panels (High Recycled Content) which is greater than 50%
- Recommended to be used with CE grid (gasketed tee flanges) for Hospitals Laboratories and Hospitals General Areas
- Certified USDA bio based product requirements for food processing areas where Clean Room™ has achieved both Bio-Preferred initiatives: Federal Procurement Preference and Certified Product Labeling
- Cleanroom classified, meets Federal Spec. 209E for non-perforated “Clean Room™ and work station Requirements, controlled environment”
- Washable, scrubbable resistance
- High humidity resistant and anti-mold, mildew growth

Applications as per 2018 FGI Guidelines:

- Class 1 MRI & Imaging Rooms
- Food Preparation
- Food Storage
- Hydro-therapy Rooms
- Laboratories
- Laundry Areas
- Pharmacies
- Ware Washing



Item	Size	Edge Detail	NRC	CAC	LR	Recycled Content	VOC Emission	Cost
 CLX625	600x1200x15	SQ	0.15	37	80%	52%	N/A	\$\$\$\$
 CLX245	610x1220x15							
 CLX665	600*600*15	SQ	0.15	37	80%	52%	N/A	\$\$\$\$
 CLX225	610*610*15							



PART 2- PRODUCT

Product Specification Details | Acoustical Ceilings | 09 51 13

2.1 General

Provide Acoustical Ceiling Material manufactured to meet requirements of this specification in accordance with ASTM E 1264 and EN 13964.

2.2 Materials

Acoustical Ceiling Units:

1. Type X, Pattern [G] [I]
2. Embossed Vinyl-faced with field cut-edges sealed with white latex paint
3. Size 15mm thick [600 x 600] [600 x 1200]
4. Edge Detail Trim (Square)
5. Noise Reduction Coefficient (NRC) [0.15]
6. Ceiling Attenuation Class (CAC) [37 dB]
7. Light Reflectance Coefficient (LR) 0.8
8. Recycled Content [52%]
9. Color White similar to RAL 9016
10. Surface Burning Characteristics per ASTM E 84 Class A, Flame Spread: 10, Smoke development: 20 Reaction to Fire: Euroclass A2-s1,d0 in accordance with EN-13501-1
11. Underwriters Laboratories Inc. Fire-Resistance (ASTM E 119) ANSI/UL 263 Time-Rated Assembly [3hrs] [D218]
12. Clean Room Classification; ISO 5 as per ISO 14644-1
13. Thermal Resistance: 0.23 m °K/W - R 1.3
14. Humidity Resistance Maximum 99% RH / 40°C
15. Weight: 5.25 kg/m²
16. Mold Prevention: Inherent to Mold/Mildew growth
17. Relevant LEED Credit: EA Credit 1 | MR Credit 4 | MR Credit 5 | MR Credit 6 | IEQ Credit 3 | IEQ Credit 3.2 | IEQ Credit 4.6 | IEQ Credit 8.1 | IEQ Credit 9
18. Product Name [Clean Room™]

HCC5

LOUNA™

STANDARD SPECIFICATION

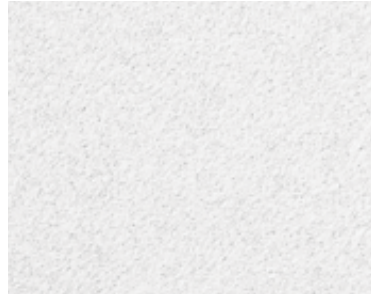

LOUNA SOUND ABSORPTION

Features & Benefits:

- Soft Fiber substrate with monolithic visual reducing installation time
- Exceptional Sound Absorption with NRC values up to 0.95
- High Light Reflectance (LR-0.88) reduces light fixtures & Energy use
- Washable & Scrubbable finish
- Impact & Scratch Resistant
- Available in Plank Sizes compatible with Logix Integrated Ceiling System

Applications as per 2018 FGI Guidelines:

- Lobbies
- Waiting Areas

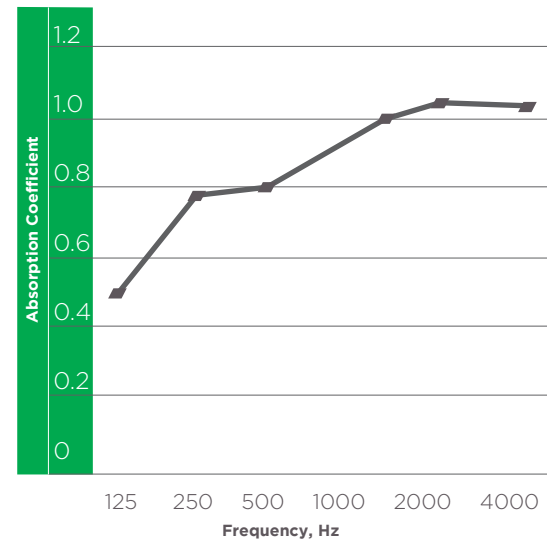

PART 2- PRODUCT

Item	Size	Edge Detail	NRC	CAC	LR	Recycled Content	VOC Emission	Cost
LC665 LC225	600*600*15 610*610*15	SQ	0.85	24	88%	40%	N/A	\$\$\$
LC669 LC229	600*600*19 610*610*19	SQ	0.95	24	88%	40%	N/A	\$\$\$\$
LC629 LC249	600*1200*19 610*1220*19	SQ	0.95	24	88%	40%	N/A	\$\$\$\$
LC6625 LC2225	600*600*25 610*610*25	SQ	0.95	28	88%	40%	N/A	\$\$\$\$

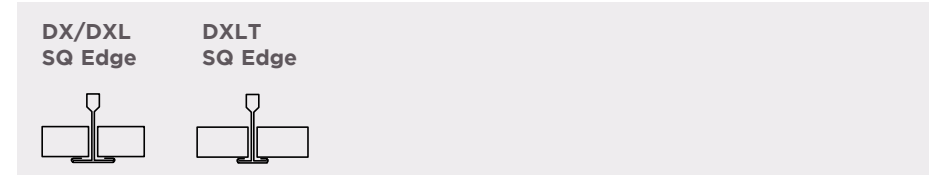

Product Specification Details | Acoustical Ceilings | 09 51 13

2.1 General

Provide Acoustical Ceiling Material manufactured to meet requirements of this specification in accordance with ASTM E 1264.

2.2 Materials

Acoustical Ceiling Units:

1. Type XII, Pattern [G]
2. Glass wool substrate finished with Fiber Glass scrim
3. Size 15, 19, 25mm thick [600 x 600] [600 x 1200]
4. Edge Detail Trim (Square)
5. Noise Reduction Coefficient (NRC) [0.85] [0.95]
6. Ceiling Attenuation Class (CAC) [24-28 dB]
7. Light Reflectance Coefficient (LR) 0.88
8. Recycled Content [40%]
9. Color White similar to RAL 9016
10. Surface Burning Characteristics per ASTM E84 Class A, Flame Spread:25, Smoke development
11. Thermal Resistance: 0.6 m² °K/W - R 3.5 (19mm), 0.74 m² °K/W - R 4.2 (25mm)
12. Humidity Resistance Maximum 99% RH / 40°C
13. Weight: 1.7 kg/m² for 15mm, 2.1 kg/m² for 19mm, 2.4 kg/m² for 25mm
14. Mold Prevention: Soft Fiber substrate is inherently resistant to the growth of mold and mildew
15. Washability / Scrubbability: Exceeds 1000 Wash/Scrub Cycles without surface break or the extent of abrasion per ASTM D4828 & D2486
16. Relevant LEED Credit: EA Credit 1 | MR Credit 4 | MR Credit 5 | MR Credit 6 | IEQ Credit 3 | IEQ Credit 3.2 | IEQ Credit 4.6 | IEQ Credit 8.1 | IEQ Credit 9
17. Product Name [Louna]

HCC6

HALCYON™ HEALTHCARE

STANDARD SPECIFICATION

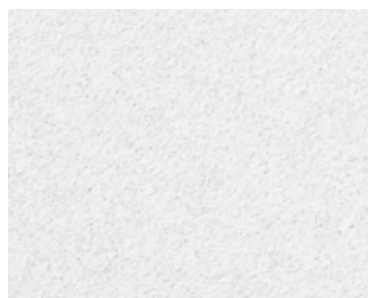

Features & Benefits:

- Water repellent membrane designed to be durable and safe with common disinfectants
- Fiber Glass substrate with monolithic visual reducing installation time
- Recommended to be used with AX grid for hospitals high-humidity or wet-cleaned areas
- Exceptional Sound Absorption with NRC values up to 1
- High Light Reflectance (LR-0.88) reduces light fixtures & Energy use
- Washable & Scrubbable finish
- Impact & Scratch Resistant
- Available in Plank Sizes compatible with Logix Integrated Ceiling System

Applications as per 2018 FGI Guidelines:

- Class 1 MRI & Imaging Rooms
- Food Preparation
- Food Storage
- Laboratories
- Laundry Areas
- Lobbies
- ICU / NICU
- Pharmacies
- Waiting Areas
- Ware Washing

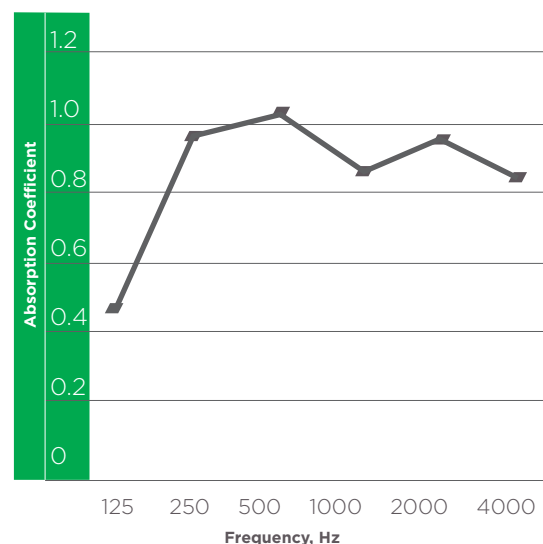

HALCYON™ HEALTHCARE SOUND ABSORPTION - 19 MM

PART 2- PRODUCT

Item	Size	Edge Detail	NRC	CAC	LR	Recycled Content	VOC Emission	Cost
HC669-HC HC229-HC	600*600*19 610*610*19	SQ	0.95	24	88%	40%	N/A	\$\$\$\$
HC629-HC HC249-HC	600*1200*19 610*1220*19	SQ	0.95	24	88%	40%	N/A	\$\$\$\$
HC6625-HC HC2225-HC	600*600*25 610*610*25	SQ	1	25	88%	40%	N/A	\$\$\$\$
HC6225-HC HC2425-HC	600*1200*25 610*1220*25	SQ	1	25	88%	40%	N/A	\$\$\$\$
HCRF6625-HC HCRF2225-HC	600*600*25 610*610*25	FL	0.95	28	88%	40%	N/A	\$\$\$\$
HCRF6225-HC HCRF2425-HC	600*1200*25 610*1220*25	FL	0.95	28	88%	40%	N/A	\$\$\$\$
HC6638-HC HC2238-HC	600*600*38 610*610*38	SQ	1	31	88%	43%	N/A	\$\$\$\$
HC6238-HC HC2238-HC	600*1220*38 610*1220*38	SQ	1	31	88%	43%	N/A	\$\$\$\$

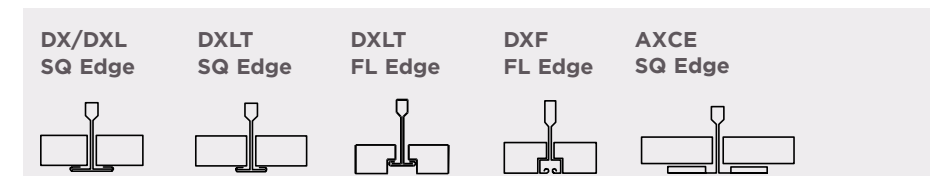

Product Specification Details | Acoustical Ceilings | 09 51 13

2.1 General

Provide Acoustical Ceiling Material manufactured to meet requirements of this specification in accordance with ASTM E 1264.

2.2 Materials

Acoustical Ceiling Units:

1. Type XII, Form 2, Pattern [E] [G]
2. Fiber Glass Substrate finished with Painted Fiber Glass scrim
3. Size 19, 25, 38mm thick [600 x 600] [600 x 1200]
4. Edge Detail Trim (Square), Reveal (SL)(FL)
5. Noise Reduction Coefficient (NRC) [0.95][1]
6. Ceiling Attenuation Class (CAC) [24-31 dB]
7. Light Reflectance Coefficient (LR) 0.88
8. Recycled Content up to [43%]
9. Color White similar to RAL 9016
10. Surface Burning Characteristics per ASTM E84 Class A, Flame Spread:25, Smoke development: 15
11. Thermal Resistance: 0.6 m² °K/W - R 3.5 (19mm), 0.74 m² °K/W - R 4.2 (25mm) 1.12 m² °K/W (38mm)
12. Humidity Resistance Maximum 99% RH / 40°C, ClimaPlus
13. Weight 2.1 kg/m² for 19mm, 2.4 kg/m² for 25mm, 3.6 kg/m² for 38mm
14. Mold Prevention: Fiberglass substrate is inherently resistant to the growth of mold and mildew
15. Washability / Scrubbability: Exceeds 1000 Wash/Scrub Cycles without surface break or the extent of abrasion per ASTM D4828 & D2486
16. Water repellent application on Top surface up to 5 Hours
17. Relevant LEED Credit: EA Credit 1 | MR Credit 4| MR Credit 5 | MR Credit 6 | IEQ Credit 3 | IEQ Credit 3.2 | IEQ Credit 4.6 | IEQ Credit 8.1 | IEQ Credit 9
18. Product Name [Halcyon™ HealthCare]



HCC7

SONATA HEALTHCARE

STANDARD SPECIFICATION

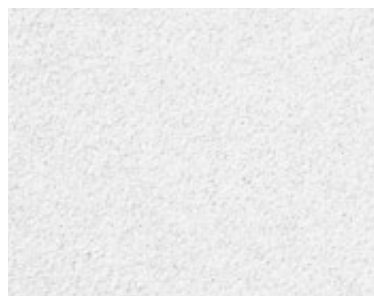

Features & Benefits:

- Sonata healthcare in normal condition face and back is ISO 4 according to the norm ISO 14644-1 : 2015
- Vibrations face and back is ISO 4 according to the norm ISO 14644-1 : 2015
- The microbiological class according to the norm NF S 90-351 : 2013 is as following: M100 / area 2 (Acinobacter baumannii), M1 / area 4 (Staphylococcus aureus MRSA, Bacillus cereus, Streptococcus pneumoniae, Escherichia coli, Candida albicans), <1 / area 2,3,4 (Aspergillus brasiliensis)
- Recommended to be used with AXCE grid (gasketed tee flanges) for hospitals restricted and semi restricted areas
- Fine, monolithic texture Industry's highest light reflectance LR 0.89 reduces light fixtures and energy use is part of Indirect lighting
- Water repellent membrane on both top and back surfaces
- High Impact and scratch resistance, durable and cleanable surface
- Available in High NRC formulation and in optimized recycled content formulations to help maximize LEED recycled content contribution
- Washable and scrubbable finish

Applications as per 2018 FGI Guidelines:

- Central Sterile Supply
- Class 1 MRI & Imaging Rooms
- Class 2 MRI & Imaging Rooms
- Clean Corridors
- Corridors
- Decontamination Rooms
- Endoscope Processing Rooms
- Food Preparation
- Food Storage
- Laboratories
- Laundry Areas
- Nurse's Stations
- Patient Rooms
- Pharmacies
- Treatment / Procedure Rooms
- Ware Washing

SONATA HEALTHCARE SOUND ABSORPTION - 19 MM

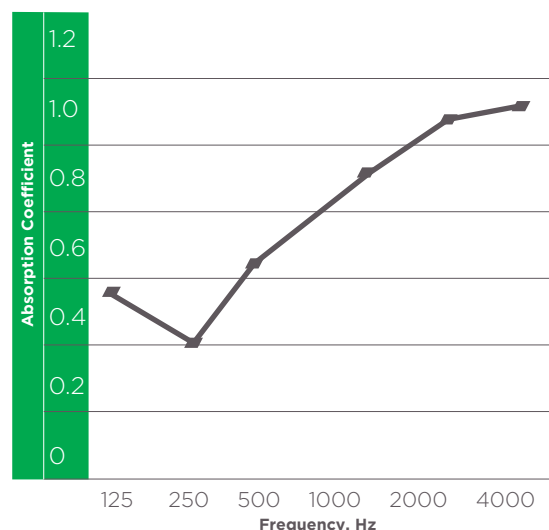

Item	Size	Edge Detail	NRC	CAC	LR	Recycled Content	VOC Emission	Cost
SC669HC SC229HC	600*600*19 610*610*19	SQ	0.75	37	89%	83%	Low	\$\$\$\$
SCR669HC SCR229HC	600*600*19 610*610*19	SLT	0.75	37	89%	83%	Low	\$\$\$\$
SCRF669HC SCRF229HC	600*600*19 610*610*19	FLB	0.75	37	89%	83%	Low	\$\$\$\$
SC629HC SC249HC	600*1200*19 610*1220*19	SQ	0.75	37	89%	83%	Low	\$\$\$\$
SCR629HC SCR249HC	600*1200*19 610*1220*19	SLT	0.75	37	89%	83%	Low	\$\$\$\$
SCRF629HC SCRF249HC	600*1200*19 610*1220*19	FLB	0.75	37	89%	83%	Low	\$\$\$\$
SC6622HC SC2222HC	600X600X22 610X610X22	SQ	0.8	40	89%	83%	Low	\$\$\$\$
SCR6622HC SCR2222HC	600X600X22 610X610X22	SLT	0.8	40	89%	83%	Low	\$\$\$\$
SCRF6622HC SCRF2222HC	600X600X22 610X610X22	FLB	0.8	40	89%	83%	Low	\$\$\$\$

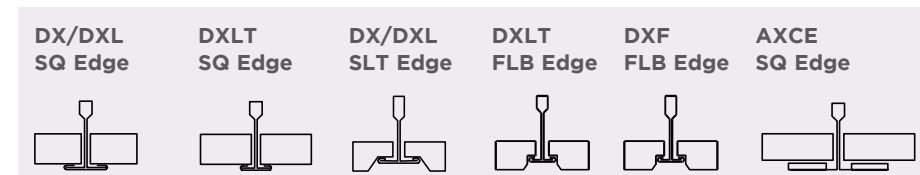

PART 2- PRODUCT

Product Specification Details | Acoustical Ceilings | 09 51 13

2.1 General

Provide Acoustical Ceiling Material manufactured to meet requirements of this specification in accordance with ASTM E 1264 and EN 13964.

2.2 Materials

Acoustical Ceiling Units:

1. Type IV, Form 2, Pattern [E] [G]
2. Mineral Fiber Substrate manufactured in wet Felted Technology and finished with Painted Fiber Glass scrim
3. Size 19, 22mm thick [600 x 600] [600 x 1200] [300 x 1200] [300 x 1500]
4. Edge Detail Trim (Square), Reveal (SLT) (FLB)
5. Noise Reduction Coefficient (NRC) [0.75] [0.8]
6. Ceiling Attenuation Class (CAC) [37-40 dB]
7. Light Reflectance Coefficient (LR) 0.89
8. Recycled Content [up to 83%]
9. Color White similar to RAL 9016
10. Surface Burning Characteristics per ASTM E84 Class A, Flame Spread:20, Smoke development:70 Reaction to Fire: Euroclass A2-s1,d0 in accordance with EN-13501-1
11. Underwriters Laboratories Inc Fire Resistance ASTM E119 ANSI/UL 263 Time-Rated Assembly (2Hrs) (J201)
12. Clean Room Classification; ISO 4 as per ISO 14644-1
13. Thermal Resistance: 0.31 m °K/W - R 1.8 (19mm)
14. Humidity Resistance Maximum 99% RH / 40°C
15. Weight: 5 kg/m
16. Mold Prevention application per ASTM D3273-1, Rate 10 per D3274
17. Washability / Scrubbability: Exceeds 1000 Wash/Scrub Cycles without surface break or the extent of abrasion per ASTM D4828 & D2486
18. Water repellent membrane on Top & Back surface up to 5 Hours
19. Relevant LEED Credit: EA Credit 1 | MR Credit 4| MR Credit 5 | MR Credit 6 | IEQ Credit 3 | IEQ Credit 3.2 | IEQ Credit 4.6 | IEQ Credit 8.1 | IEQ Credit 9
20. Product Name [Sonata HealthCare]

HCC8

SPARTA

STANDARD SPECIFICATION

Plain White



Star Plus



Features & Benefits:

- Laminated Washable Vinyl facing for easy maintenance
- Available only in Plain facings with smooth appearance for Plain White pattern and light texture for Star Plus pattern
- Ultra high humidity resistant and sag resistance ensures durability in standard or extreme environmental conditions. May be installed early in the hospital program
- It comes with Aluminum Foil backing which acts as a vapor barrier and resists breathing so panel stays cleaner longer
- Scrub resistant. Dirt marks are easy to remove
- Scuff and scratch resistant, for longer life
- Very suitable for Healthcare applications
- Economical and easy to trim and install

Applications as per 2018 FGI Guidelines:

- Hydro-therapy Rooms
- Nurse's Stations
- Patient Rooms



Item	Size	Edge Detail	NRC	CAC	LR	Recycled Content	VOC Emission	Cost
LSP665	600*600*15	SQ	0.15	35	84%	32%	Low	\$
LSP225	610*610*15							
LPW665	600*600*15	SQ	0.15	35	84%	32%	Low	\$
LPW225	610*610*15							
LSP669	600*600*19	SQ	0.15	36	84%	32%	Low	\$\$
LSP229	610*610*19							
LPW669	600*600*19	SQ	0.15	36	84%	32%	Low	\$\$
LPW229	610*610*19							

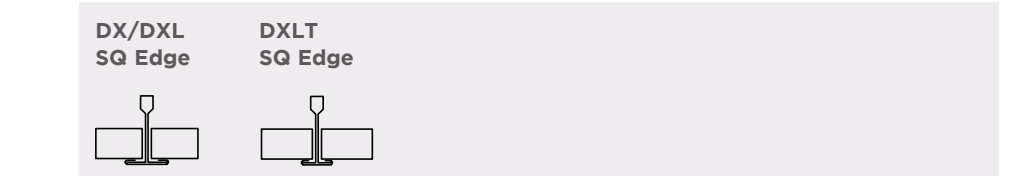

PART 2- PRODUCT

Product Specification Details | Acoustical Ceilings | 09 51 13

2.1 General

Provide Acoustical Ceiling Material manufactured to meet requirements of this specification in accordance with ASTM E 1264.

2.2 Materials

Acoustical Ceiling Units:

1. Type X, Pattern [G]
2. Smooth and textured laminated panels
3. Size 15, 19mm thick [600 x 600]
4. Edge Detail Trim (Square)
5. Noise Reduction Coefficient (NRC) [0.15]
6. Ceiling Attenuation Class (CAC) [35-36 dB]
7. Light Reflectance Coefficient (LR) 0.84
8. Recycled Content [32%]
9. Color White similar to RAL 9016
10. Thermal Resistance: 0.23 m² K/W - R 1.3 (15mm), 0.31 m² K/W - R 1.8 (19mm)
11. Clean Room Classification; ISO 5 as per ISO 14644-1
12. Humidity Resistance Maximum 99% RH / 40°C
13. Weight: 3.5 kg/m² 15mm, 4.5 kg/m² 19mm
14. Mold Prevention: Inherent to Mold/Mildew growth
15. Relevant LEED Credit: EA Credit 1 | MR Credit 4 | MR Credit 5 | MR Credit 6 | IEQ Credit 3 | IEQ Credit 3.2 | IEQ Credit 4.6 | IEQ Credit 8.1 | IEQ Credit 9
16. Product Name [Sparta]

HCC9

TAIGA HYGIENE

STANDARD SPECIFICATION

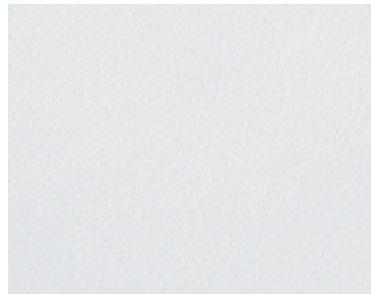

Features & Benefits:











- Taiga Hygiene in normal condition face and back is ISO 4 according to the norm ISO 14644-1 : 2015
- Vibrations face and back is ISO 4 according to the norm ISO 14644-1 : 2015
- The microbiological class according to the norm NF S 90-351 : 2013 is as following: M100 / area 2 (Klebsiella pneumoniae), M1 / area 4 (Acinobacter baumannii, Staphylococcus aureus MRSA, Bacillus cereus, Streptococcus pneumoniae, Escherichia coli, Candida albicans), <1 / area 2,3,4 (Aspergillus brasiliensis)
- Taiga Hygiene has been developed to meet the most stringent demand on hygiene and clean ability
- All Taiga Hygiene items have a special fungicide treatment in the core and on the finished painted surface to enhance the resistance to growth of micro-organisms and ensure regular clean ability. It contains a broad spectrum antimicrobial additive on the face and the back of the panel that provides resistance against the growth of mold and mildew
- High light reflectance performance 86%
- High humidity resistant in ClimaPlus, suitable for applications with intermittent heating and Cooling

Applications as per 2018 FGI Guidelines:

- Class 1 MRI & Imaging Rooms
- Laboratories
- Nurse's Stations
- Patient Rooms
- Pharmacies



PART 2- PRODUCT

Item	Size	Edge Detail	NRC	CAC	LR	Recycled Content	VOC Emission	Cost
 NA4107M-ME	600*600*15	SQ	0.15	33	86%	32%	Low	\$\$
 NA4107M-IM	610*610*15							
 NB4107M-ME	600*600*15	SLT	0.15	33	86%	32%	Low	\$\$
 NB4107M-IM	610*610*15							
 NC4107M-ME	600*600*19	FLB	0.15	36	86%	32%	Low	\$\$
 NC4107M-IM	610*610*19							
 NA4997M-ME	600*600*19	SQ	0.15	36	86%	32%	Low	\$\$\$
 NA4997M-IM	610*610*19							
 NB4997M-ME	600*600*19	SLT	0.15	36	86%	32%	Low	\$\$\$
 NB4997M-IM	610*610*19							

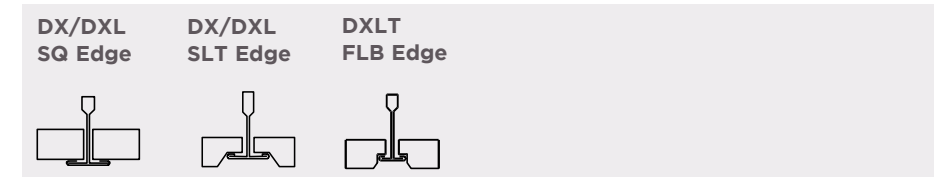

Product Specification Details | Acoustical Ceilings | 09 51 13

2.1 General

Provide Acoustical Ceiling Material manufactured to meet requirements of this specification in accordance with ASTM E 1264 and EN 13964.

2.2 Materials

Acoustical Ceiling Units:

1. Type III, Form 2, Pattern [G]
2. Plain finish panels
3. Size 15, 19mm thick [600 x 600]
4. Edge Detail Trim (Square), Reveal (SLT)
5. Noise Reduction Coefficient (NRC) [0.15]
6. Ceiling Attenuation Class (CAC) [33-36 dB]
7. Light Reflectance Coefficient (LR) 0.86
8. Recycled Content [32%]
9. Color White similar to RAL 9016
10. Surface Burning Characteristics per ASTM E 84 Class A, Flame Spread: 10, Smoke development: 20 Reaction to Fire: Euroclass A2-s1,d0 in accordance with EN-13501-1
11. Thermal Resistance: 0.23 m °K/W - R 1.3 (15mm), 0.31 m °K/W - R 1.8 (19mm)
12. Clean Room Classification; ISO 4 as per ISO 14644-1
13. Humidity Resistance Maximum 99% RH / 40°C for ClimaPlus
14. Weight: 3.5 kg/m 15mm, 4.5 kg/m 19mm
15. Mold Prevention application per ASTM D3273-1, Rate 10 per D3274
16. Washability / Scrubbability: Exceeds 1000 Wash/Scrub Cycles without surface break or the extent of abrasion per ASTM D4828 & D2486
17. Relevant LEED Credit: EA Credit 1 | MR Credit 4 | MR Credit 5 | MR Credit 6 | IEQ Credit 3 | IEQ Credit 3.2 | IEQ Credit 4.6 | IEQ Credit 8.1
18. Product Name [Taiga Hygiene]

DONN® EXPOSED GRID FOR HEALTHCARE APPLICATION

DONN® DX 24mm EXPOSED GRID

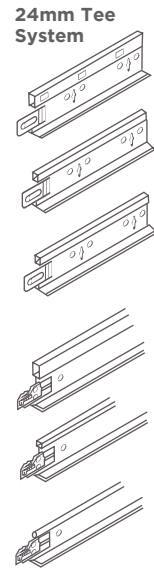

	PROFILE	PRODUCT	PROFILE HEIGHT	COMPONENT LENGTH	THICKNESS
MAIN TEE	Deep	Heavy-Standard	38mm	3600/3660mm	0.30mm
		Fire Rated	38mm		0.38mm
	Medium	Intermediate Duty	33mm	3600/3660mm	0.30mm
	Shallow	Light Duty	30 mm	3600/3660mm	0.30mm
CROSS TEE	Deep	Fire Rated	38mm	1200/1220mm	0.30mm
		Fire Rated	38mm	600/610mm	
	Medium	Intermediate Duty	33mm	1200/1220mm	0.30mm
		Intermediate Duty	33mm	600/610mm	
	Shallow	Light Duty	25.5mm	1200/1220mm	0.30mm
		Light Duty	25.5mm	600/610mm	
	A Square Edge (SQ)	B Shadowline Tapered (SLT)	C Shadowline (SL)	D Shadowline Bevel (SLB)	
USG Boral ME Panel Edge Detail					

DONN® CENTRICITEE 15mm EXPOSED GRID

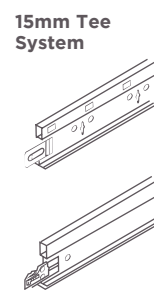

	PROFILE	PRODUCT	PROFILE HEIGHT	COMPONENT LENGTH	THICKNESS
MAIN TEE	Deep	Main Tee-Centricitee Heavy Duty- Fire Rated	38mm	3600/3660mm	0.38mm
CROSS TEE	Deep	Cross Tee (Heavy) Cross Tee (Heavy)	38mm 38mm	1200mm 600mm	0.30mm
	A Square Edge (SQ) ²	B Fineline Bevel Edge (FLB)	C Fineline (FL)	D Interline Tapered (ILT)	Patented self centering device in cross tees automatically centers ceiling panel grid module
USG Boral ME Panel Edge Detail					

Fire Rated Option
 DONN® DXLT24 is available as a Fire Rated upon request option providing protection up to 2 hours, subject to assembly design
 DONN® DXLT15 is available only as a Fire Rated option providing protection up to 2 hours, subject to assembly design

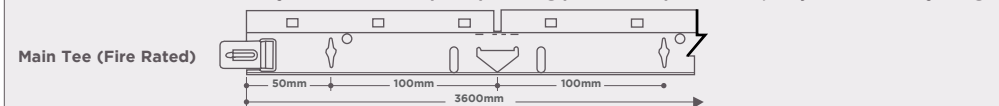

USG DONN® BRAND CE™ ACOUSTICAL SUSPENSION SYSTEM

Features & Benefits:

- Meets 2018 Guidelines For Healthcare Facilities. Grid system with factory-applied white, closed-cell foam gaskets for controlled environments.
- Min.G30 **hot-dipped galvanized** body provides corrosion protection. Supports Clean Room HEPA filters and lights.
- ICC-ES evaluated for building code compliance and seismic installations (ICC-ESR-1222)
- Capable of withstanding cleaning and/or disinfecting chemicals as tested in accordance with ASTM D402

Applications as per 2018 FGI Guidelines:

- Clean rooms
- Hospitals
- Food processing areas
- Healthcare facilities
- Certified to meet ISO 14644-1 Class 5 (Fed.Standard 209E Class 100)

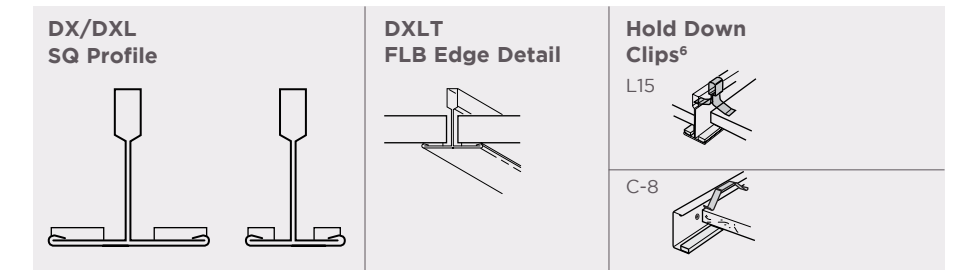

USG DONN® BRAND AX™ /AXCE™ ACOUSTICAL SUSPENSION SYSTEM

Features & Benefits:

- Meets 2018 Guidelines For Healthcare Facilities.
- Noncorrosive **aluminum** 15/16" exposed grid system with stainless steel clip, ideal for high-humidity or wet-cleaned areas.
- Capable of withstanding cleaning and/or disinfecting chemicals as tested in accordance with ASTM D5402.
- Tested for environmental conditions in accordance with ASTM C635.
- Aluminum components can be used in nonmagnetic environments and meet USDA/FSIS requirements.
- Cross-tee override-ends resist twisting and give a professionally finished look.
- Proprietary stainless steel Quick-Release™ clip.
- Up to 90% recycled content.
- Factory applied, white closed cell foam gasket.

Applications as per 2018 FGI Guidelines:

- Healthcare facilities, restricted and semi-restricted areas
- MRI rooms
- Magnetic-free zones
- High-humidity areas
- Food processing areas
- Certified to meet ISO 14644-1 Class 5 (Fed. Standard 209E Class 100)

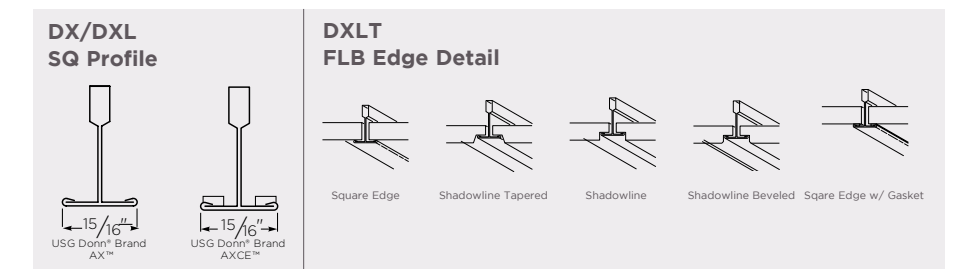

DONN® SUSPENSION SYSTEM SEISMIC SOLUTIONS

Categories D, E, and F Category C

System Summary

Suspension System Duty Rating	Heavy
Wall Molding	7/8"
Seismic Clip	ACM7
Two Adjacent Floating Sides - With Gap	3/49 gap; ACM7 seismic clip with fastener attachment to tee through slot (optional), and no fastener through wall molding.
Two Adjacent Fixed Sides - Tight, No Gap	Tight, no gap; ACM7 seismic clip with fastener attachment to tee (optional), and one fastener through wall molding (optional)
Perimeter Hanger Wires	Yes
Stabilizer Bars	None

Construction Details

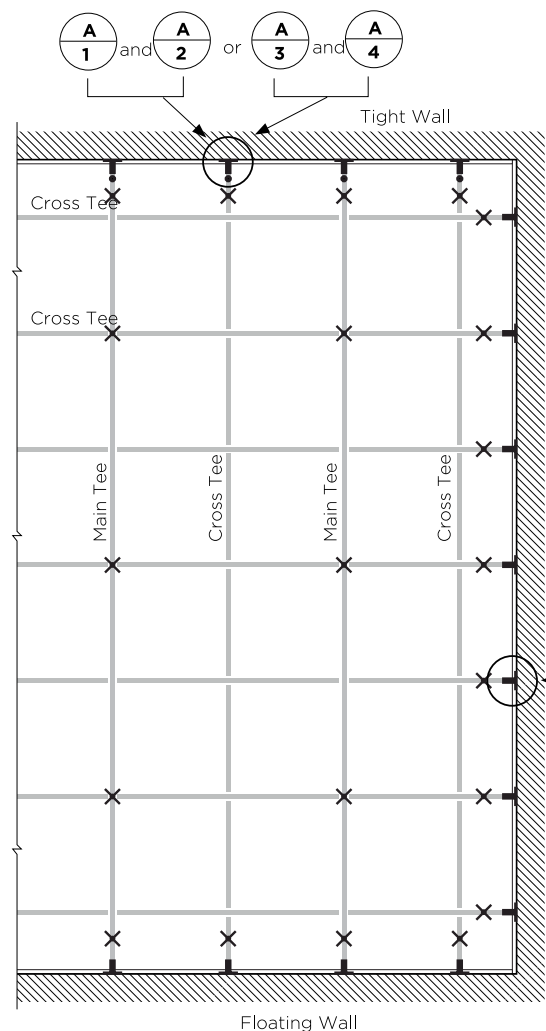

- X -12gauge hanger wire
- T ACM7 seismic clip
- T ACM7 seismic clip or riveted

All main DONN® suspension systems - DX/DXL, Finline DXF, Finline 1/8 DXFF, Centricitee DXLT/DXLT, CE, DXW, DXLA, and ZXLA - include the Code compliant and heavy-duty main tees for Seismic Design Categories D, E, and F.

For ceiling areas exceeding 2,500 ft.2 (232 m²), a seismic separation joint may be required. See SC2496 for information on seismic separation joints.

The performance of DONN® seismic systems is based on the specific combination of superior components, and design and installation methods shown. Components from other manufacturers were not evaluated, and their use or any mixed use is not recommended.

Convenience holes located in the tee bulb may be used for any and all hanger wires.

ACM7 Clip, Tight Wall

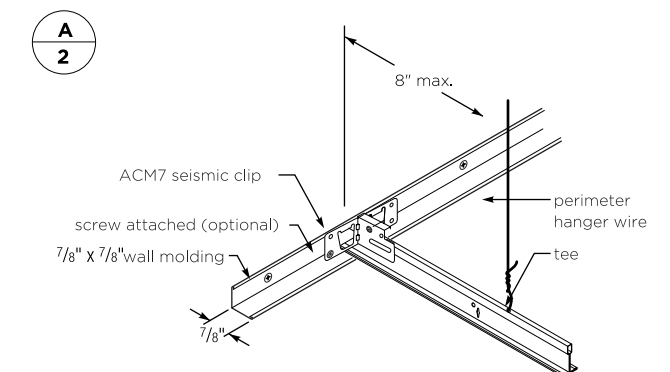
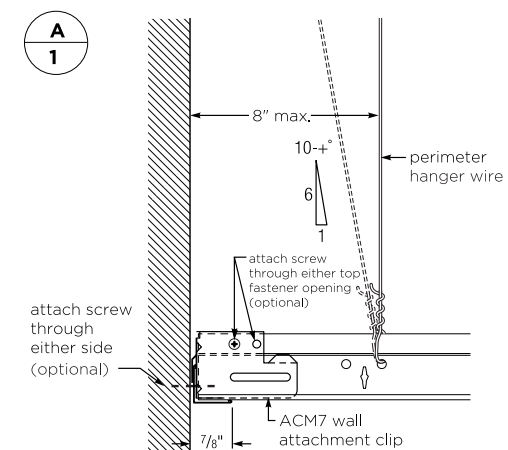

Tee Rivet, Tight Wall

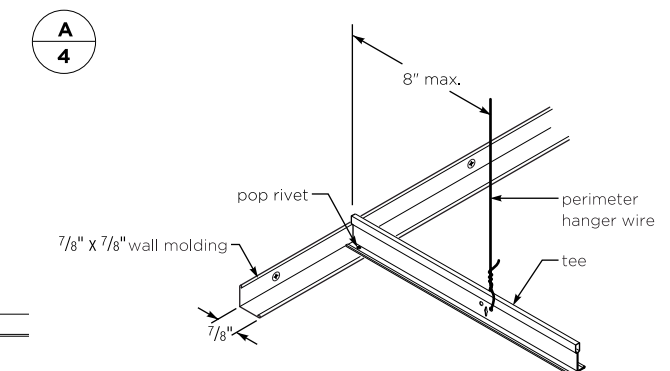
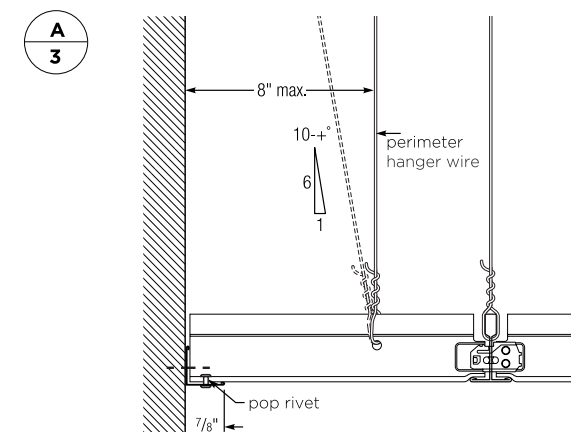

ACM7 Clip, Tight Wall

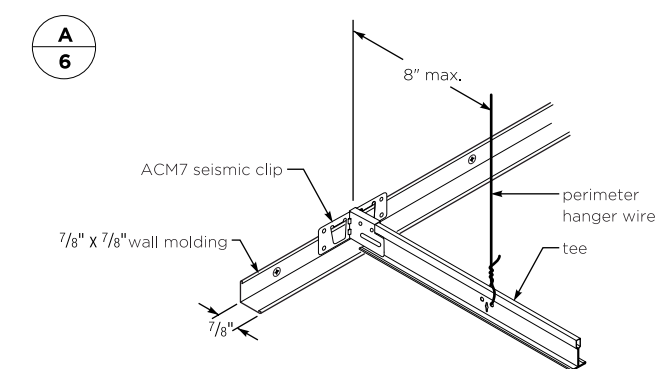
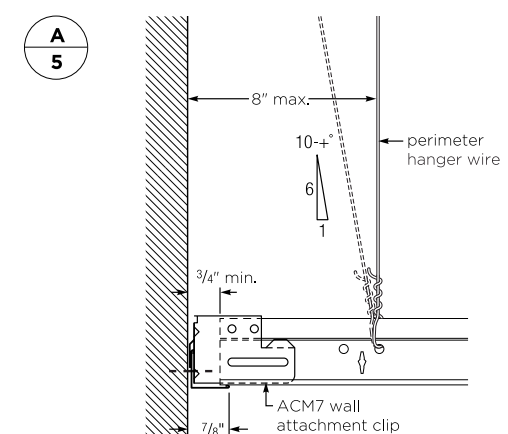

ENVIRONMENTAL AIR QUALITY

INDOOR AIR QUALITY

The Indoor Air Quality is affected equally by heating, ventilation and air conditioning, construction engineering, the quality of construction work, building materials as well as the operation and maintenance of the building. USG Boral ME Ceiling panels do not contain asbestos, carcinogens, mutagens or substances toxic to reproduction. It is important to identify the indoor-related time value, which is the time it takes from the installation of a product until the emission of ammonia, formaldehyde, VOC (Volatile Organic Compounds) and particles to decay below specified levels. This is based on odour and mucus irritation thresholds for eyes and the upper respiratory passage as well as standard room considerations. USG Boral ME products are classified to have low impact on indoor air quality. Even when installed in a fully furnished room with very little fresh air, the concentrations of VOCs & Formaldehyde are well below acceptable levels.

Clean Room Classification

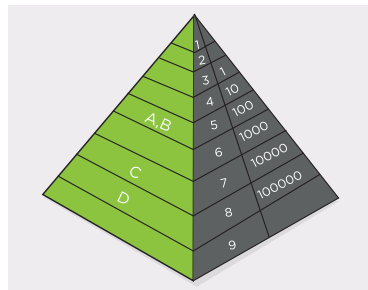

All USG Boral ME products are classified as E1 products which guarantee that the products are below the lowest EU requirement for Formaldehyde emission.

- Many USG Boral ME ceiling panels help to support healthy environments with reduced Volatile Organic Compound (VOC) emissions: Ceiling with Little or No Formaldehyde Requirements as per CHPS (Collaborative For High Performance Schools)
- Zero VOC Emission for All CAST Ceilings (level < 2mg or 1.6 ppb)
 - Low-Emitting Ceilings (level < 9 µg/m³)
 - Meets minimum Standards (state of Washington Level < 50 ppb)

CLEANLINESS

The dust particles can also impact on the health of people and be critical in special industries in the pharmaceutical, electronics and food industries and in certain hospital environments.

The international EN ISO 14644-1 standard (classes 1 to 9) is used for the classification of air cleanliness. This is the official standard, but the US Federal standard 209E (classes 1 to 100 000) is also widely spread.

TABLE 10: CLEAN ROOM™ CLASSIFICATION

FED STD 209D/209E		ISO 14644-1	Industry Application Areas		
English	Metric	ISO Class			
-	-	1			
-	-	2			
1	M1.5	3	Micro-electronics		
10	M2.5	4			
100	M3.5	5			
1,000	M4.5	6		Pharmaceutical	Electronics and Food
10,000	M5.5	7			
100,000	M6.5	8			Automotive and Space
-	-	9			

A selective number of USG Boral ME products are certified class ISO 5 meeting the requirement of demanding clean rooms in regard to particle emissions.

MOLD PREVENTION

NO GROWTH OF MICRO-ORGANISMS

Excessive humidity and moisture in a hospitals can promote the development of microorganisms such as mold or bacteria and cause allergic reactions, respiratory illness or skin problems.

YOU CONTROL MOISTURE. WE HELP CONTROL MOLD

USG Boral ME address the issue of mold and microbial growth by providing acoustical ceiling tiles treated with a USG Boral ME antimicrobial treatment that provides broad spectrum control for mold/mildew.

USG Boral ME's position on ASTM D3273 and ASTM C473

In the absence of specific tests for the broad category of construction products, the industry uses ASTM C473 and D3273. ASTM C473 measures water absorption of panels as a percentage of weight. ASTM D3273 measures resistance to mold growth on the surface of interior coatings rather than building materials. These test results do not represent definitive installed performance in specific project conditions. Products are being classified out of this test per ASTM D3274 where Rate 10 is designated for No Growth of Mold after 4 weeks Incubation. Special Products for HealthCare application like Taiga Hygiene & Sonata HC comes directly with Mold Prevention application per ASTM D3273.

PRODUCTS ALONE CANNOT CONTROL MOISTURE OR PREVENT MOLD

All products become susceptible to mold growth under unfavorable conditions. The EPA has found that mold will grow even on stainless steel, glass and all surfaces, given the right conditions.

In addition to mold growth, it is now important to install products that have low impact on Indoor Air Quality on other term on Comfort and Health.

WATER SHIELD



In its continuous improvement, USG Boral ME offers an invention in mineral fiber ceiling tiles.

Normally, the ceiling tiles have a tendency to stain when in contact with water due to condensation on pipes and duct work above the ceiling. The condensate can drip into the backside of the ceiling tiles and migrate to the visible side of the tile.

The water droplets can leach tannin from recycled materials and other cellulose based materials and staining agent from the paint surface of the tile.

USG Boral ME's new invention provides an economical solution to minimize water stains at the visible face of the panel. This invention creates a barrier to water droplets at the backside of the panel allowing the droplet to evaporate before it can migrate through the panel.

This treatment provides a Water Shield to mineral fiber tiles in a practical and cost effective way.

Sonata™ & Halcyon™ for HealthCare application features with Water repellent membrane on it's finished surface for more durable and safety with common disinfectant. It Exceeds FGI 2018 guidelines for healthcare applications and meets USDA/FSIS guidelines for use in food-processing areas. It Achieve FDA standards for being smooth, durable and easily cleanable- all of which can enhance the indoor environmental quality of your healthcare spaces.

**HEALTHCARE
INTERIOR FINISHES**



FINISHING SOLUTIONS

USG Boral ME Offering the industry's broadest selection of finishing solutions, our high-quality joint compounds, joint tapes, beads and trims deliver superior performance for every job, every time. Whether you're taping, applying a finish coat or patching a crack, there is a USG Boral finishing product to meet your needs.

1. Joint Compounds, Ready Mixed

USG Boral ME ready-mixed joint compounds are drying-type products that are vastly superior to ordinary ready-mixed compounds and are preferred for consistently high-quality work. These formulations are specially premixed to a creamy, smooth consistency essentially free of crater-causing air bubbles. They offer excellent slip and bond and easy workability. Available for hand or machine-tool applications.

SHEETROCK® All Purpose Joint Compound

Air-drying, lightweight compound suitable for all three coat applications or as a finishing coat for all plasterboard joints, angles and fastener heads. Complies with ASTM C475.



- Premium grade lightweight, all purpose or finishing compound.
- May be used for all three coats or as a finishing coat.
- Excellent workability, easy application by hand or with mechanical tools.
- Minimal mixing & cleaning of tools.
- Can be sanded by hand or with mechanical sanding tools.
- Excellent surface for painting.

Premium Premix Joint Compound

Air-drying lightweight compound suitable for all three coat applications or as a finishing coat for all plasterboard joints. Angles and fastener heads. Complies with ASTM C475.



- Minimal shrinkage
- Easy sanding
- Exceptional crack-resistance
- Excellent bond
- Smooth finish

2. Joint Compounds, Lightweight

SHEETROCK® Brand Dust Control Joint Compound

Sheetrock® Brand Dust Control Joint Compound creates less mess and offers faster cleanup.



- Dust-control formulation substantially reduces airborne dust (independently verified with Worker Industrial Hygiene Testing)
- Weighs up to 25% less than conventional compounds
- Low shrinkage — requires only two coats over metal
- Sands with the ease of a topping compound
- Great for remodeling projects
- Achieved GREENGUARD Gold Certification and qualifies as a low VOC emitting material (CDPH Standard Method V1.1, also known as CA Section 01350)

SHEETROCK® Lightweight All-Purpose Joint Compound

More flexible and easier than other joint compounds for embedding joint tape and for filling and finishing gypsum panel joints, corner bead, trim and fasteners. Also for hand-applying simple textures. Complies with ASTM C475.



- For professional drywall finishing
- High performance compound.
 - Minimizes cratering.
 - Excellent workability (including better slip and pull).
 - Low shrinkage, easy sanding.

3. Joint Compound, Powder Form

SHEETROCK® BRAND Drying-Type Powder Joint Compounds



- For Superior Drywall Finishing
- Fast smooth application.
 - Three job-tested types—taping, topping, all purpose.
 - Easy to mix, offer ample working time.
 - Retain consistency—will not thin out or settle.
 - Can be used for simple, hand-applied textures.

General Purpose Basecoat



- Specially formulated for cement board system.
- High flexibility.
- Good bonding to the substrate.
- Designed for use in EIFS systems.
- Asbestos-free product.

DUROCK® Basecoat



- Specially formulated for Durock® system.
- High flexibility.
- Exceptional bond to the substrate.
- High performance designed for use in EIFS system.
- Asbestos-free product.

SHEETROCK® BRAND DURABOND® JOINT COMPOUND



Sheetrock® Brand Durabond® Joint Compounds provide a hard, plaster-like surface when dry and are virtually unaffected by humidity.

- Used for interior Fiberock® Jointing panels
- Unique humidity resistance
- Exceptional bond, low shrinkage
- Unusual check-crack resistance in heavy fills
- Choice of setting times

3. Joint Tapes

From the originator of modern joint finishing, USG Boral reinforcing tapes add strength and crack resistance for smooth concealment at flat joints and inside corners. USG Boral joint tapes are high quality and easily applied, and are available for specialized uses.

To prevent cracking and ensure good joint performance, paper tape is always recommended. These products must be used with ready-mixed compounds to ensure good joint performance. While the high strength of setting-type compounds produces a strong joint with either paper or fiberglass mesh tape, even with setting-type compounds, paper joint tape performs best.

SHEETROCK® Brand Paper Joint Tape



For strength and crack resistance in drywall joint treatment

- High tensile strength to resist tearing, stretching and distortion
- Wafer-thin paper for easier joint treatment
- Roughened surface for superior bond
- Accurately center-creased to improve corner treatment

SHEETROCK® Brand Fiberglass Drywall Tape

While fiberglass mesh tape is stronger than paper tape in expansion under ultimate tensile load, it does not reinforce the joint compound in compression, bending or shear, and will allow visible cracking of the joint compound to occur at lower loads as the glass mesh stretches. The only time USG Boral recommends mesh tape is when you're using our fiberglass drywall tapes with USG setting-type joint compounds.



Unique cross-fiber construction provides greater drywall joint strength and crack resistance

- Self-adhesive tape goes on quickly—eliminates bedding coat and provides smooth finished joints with just two coats.
- Use Sheetrock® Brand DURABOND® Setting-Type Joint Compound or Sheetrock® Brand EASY SAND™ Lightweight Setting-Type Joint Compound for first coat over tape.
- Provides 2-coat, 1-day joint finishing.

Durock® Brand Interior And Exterior Tapes



For joint reinforcement of USG Durock® Brand Cement Board, USG Fiberock® Brand Underlayment and Tile Backerboard, USG Durock® Brand Glass-Mat Tile Backerboard, and USG Durock® Brand UltraLight Foam Tile Backerboard.

- Alkali-resistant glass-fiber construction
- Reinforces joints and corners of cement board in exterior substrate applications and interior tile or thin-brick applications
- Sizes for interior (2" wide) and exterior (4" wide) joint reinforcement

4. Preparation Solutions

SHEETROCK® Brand Tuff Hide™ Primer-Surfacer



Skim coats and primes in one spray application

- Achieves a Level 5 finish faster
- High build spray for a smoother, more beautiful finish
- Durable coating hides minor surface defects
- Excellent for critical light areas
- Ideal finish for ceilings
- Dries white; can be tinted to match final top coat
- For professional use only

SHEETROCK® Brand Acoustical Sealant



Makes promised ratings a reality

- Excellent sound-flanking material (supports high acoustic ratings)
- Superior performance as a fire caulk in UL Classified joint and through penetration firestop systems
- Ideal for use in smoke and/or sound assemblies
- Meets ASTM C834 specifications for latex sealants
- Grade 0°F (-18°C) low temperature flexibility, strong bond
- Low VOC

5. Finishing Solutions

USG Boral Ensemble Finish



- Acoustically transparent, technologically advanced formulation
- White color with a fine, granular texture
- High light reflectance (LR-0.85)
- Lightweight, only 12kg per 17L pail
- Quick drying, recoat in 20-40 minutes
- Applied with pneumatic spray equipment for economical installation



COMPANY CERTIFICATION AND COMPLIANCE

ENVIRONMENTAL STATEMENT

Recycling is only a part of the story. Careful production methods are good for the environment and increase efficiency. Our practices include:

- Using clean fuels (NG)
- Treating and recycling water (Saving of 300 m3 daily at USG Boral ME)
- Reducing waste (Recycling): Waste from the production line and panels chipped or broken during processing are returned to the manufacturing cycle, keeping them out of landfills
- Offering specialized ceiling panels and wallboards: High-durability acoustical panels extend the useful life of ceilings and walls and reduce operating and replacement costs. Ceiling panels with high light reflectance can enhance indirect lighting, reducing the number of light fixtures needed and lowering energy consumption
- Recycling old ceiling and wallboards panels
- Product life cycle: USG Boral ME's commitment to health, safety and environmental responsibility is evident at every stage in the life cycle chain. USG Boral ME has been granted to ISO 14000 certificate. This indicates that environmental aspects such as emissions into the air, waste handling, utilization of natural resources and energy efficiency are paid attention to at USG Boral ME and the environmental impacts of production are constantly improved. In addition to ISO 14000 certification, USG Boral ME is working to prove the environmental profile of USG Boral ME products by acquiring EPD (Environmental Product Declaration) to it's Ceiling family range.

LEED REQUIREMENTS

USG Boral team can assist you with the required LEED documentation whether you require pre-consumer or post-consumer recycled content for the material being used or other documents.

ASBESTOS FREE

USG Boral acoustical ceiling tiles, gypsum boards and Jointing Compounds have been tested for asbestos content where no asbestos content result was obtained.

GREEN FACTS

- More than 70% of manufacturing waste is recycled into ceiling products
- The majority of the Ceilings product offering contains 50% recycled content or higher
- USG Boral ME mineral fiber ceiling panels incorporate steel mill slag waste as well as post-consumer waste
- USG Boral ME has an Environmental certificate for it's facility in Dammam for compliance with PME (Presidency of Metrology and Environment) according to Local regulations
- All USG Boral ME panels feature low VOC emission and comply with the Collaborative for High Performance Schools (CHPS) standards

ISO CERTIFICATION

USG Boral Middle East is up to date with the latest ISO 9001:2015 and ISO 14001:2015 Certifications.



Australia
China
India
Indonesia
Malaysia
Middle East
New Zealand
Thailand
Philippines
Singapore
South Korea
Vietnam

**7410 (Wasil), Street #23, Cross 76, 2nd Industrial City
Dammam 34326-4201, Kingdom of Saudi Arabia**

+966 13 812 0095 info@usgme.com